

Welcome to the MLD archive  
for product developers.

© MLD Studio

Click, swipe or scroll to start slideshow.

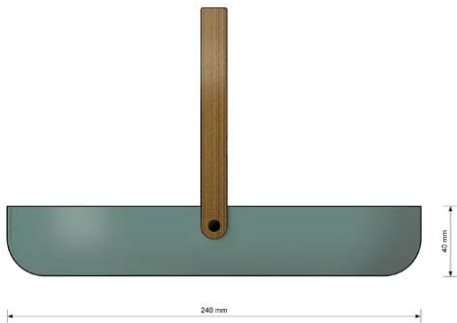

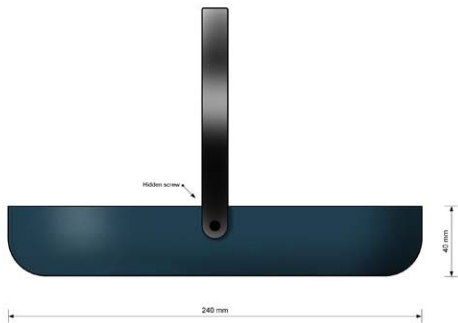

MATERIAL CANVAS

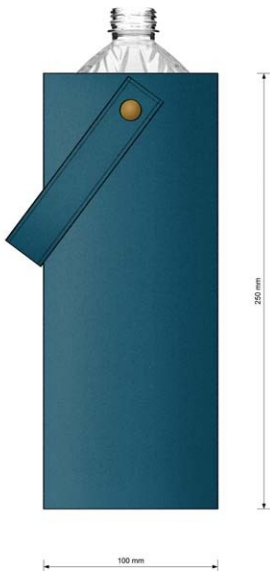

MATERIAL CANVAS



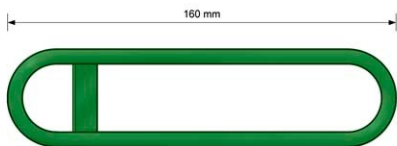
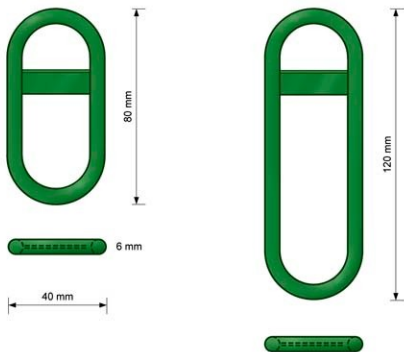

MATERIAL METAL

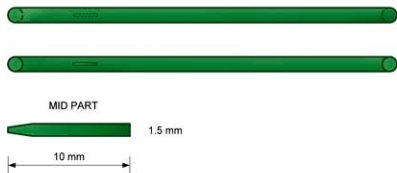

MID PART

1.5 mm

10 mm

CANDLEHOLDER GLASS  
2010-04-19  
MAGNUS LÖFGREN DESIGNS  
Design: Magnus Löfgren  
Copyright

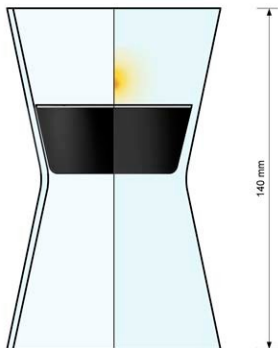

MATERIAL GLASS / METAL / WOOD

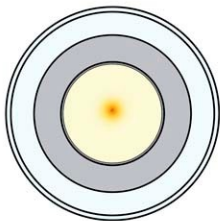

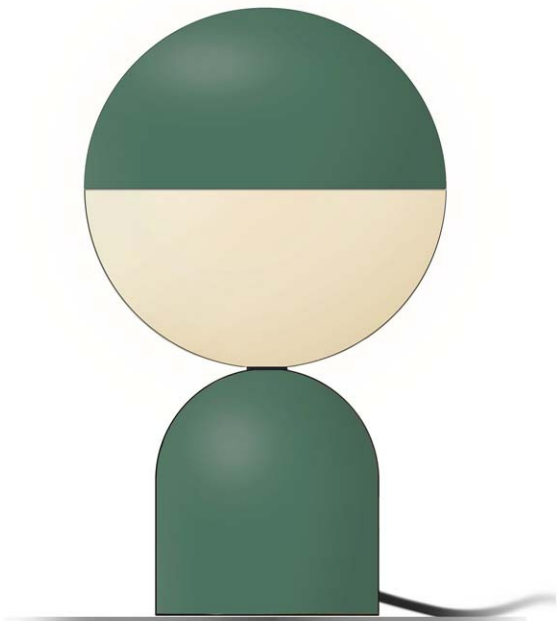



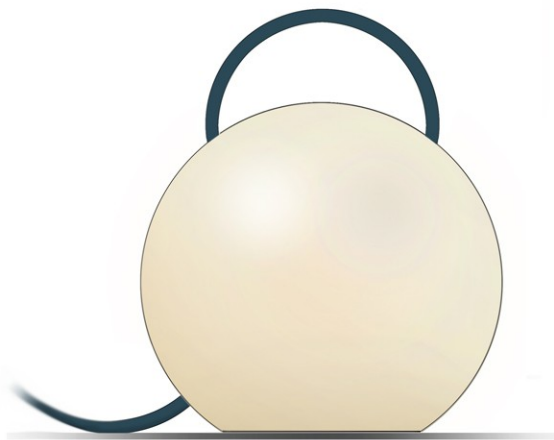

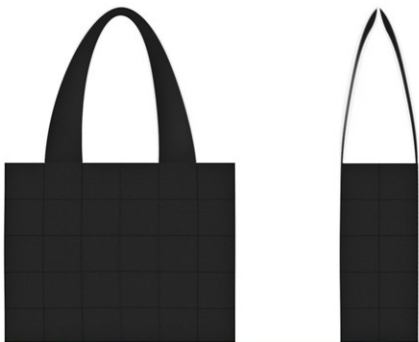

MATERIAL: 60mm TEXTILE RIBBON

CUTTINGBOARD WITH KNIFE

MATERIAL PLASTIC

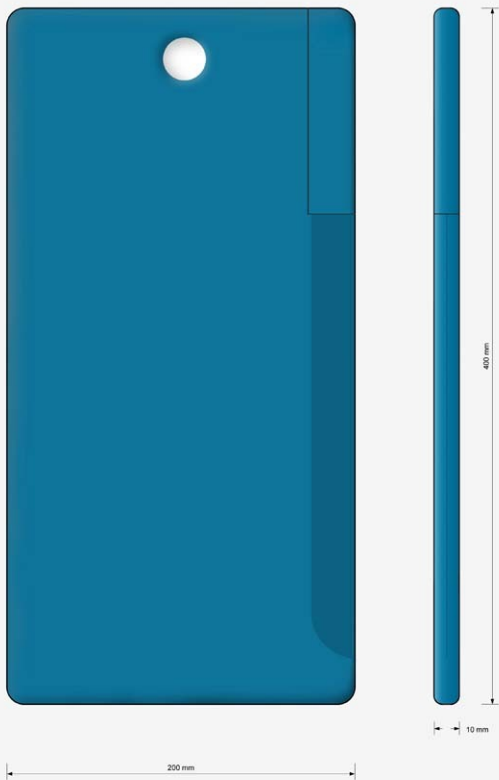

CUTTINGBOARD WITH KNIFE

MATERIAL PLASTIC



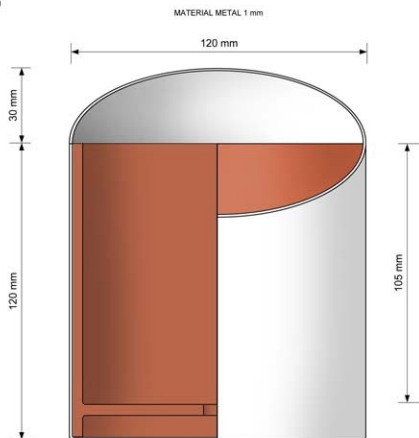

INNER POT IN CERAMIC MATERIAL

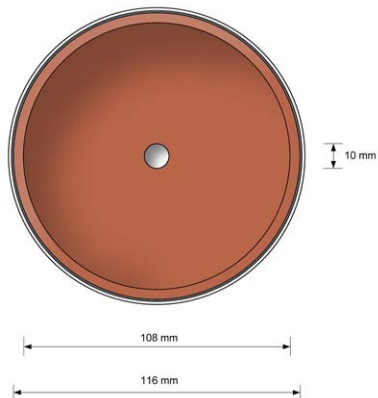

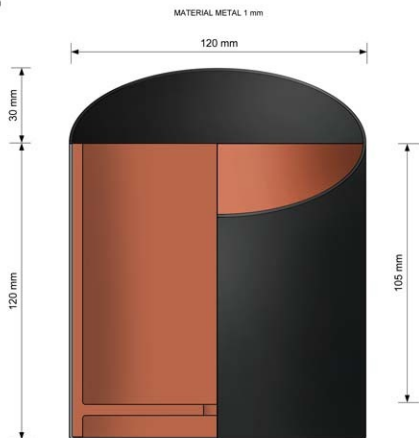

INNER POT IN CERAMIC MATERIAL

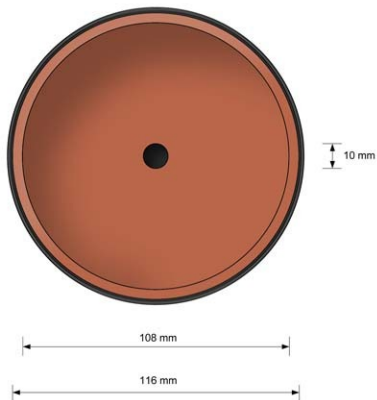

MATERIAL METAL 1 mm

120 mm



INNER POT IN CERAMIC MATERIAL

MATERIAL METAL 1 mm

120 mm



INNER POT IN CERAMIC MATERIAL



MATERIAL METAL 1.5 mm

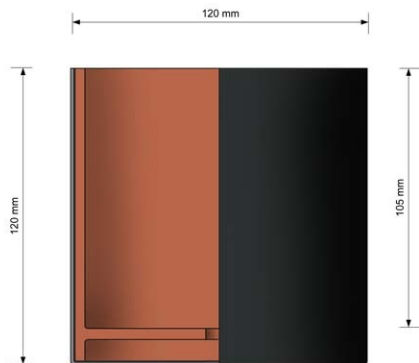

INNER POT IN CERAMIC MATERIAL

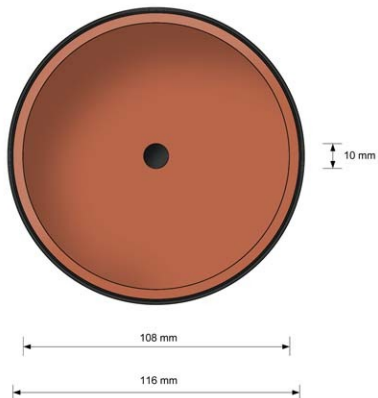

MATERIAL METAL 1.5 mm

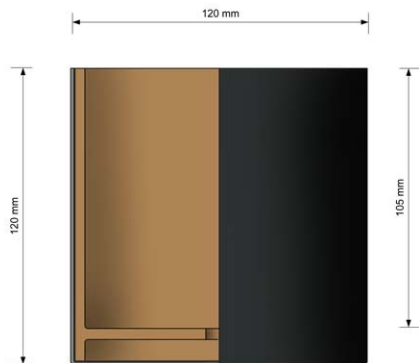

INNER POT IN CERAMIC MATERIAL

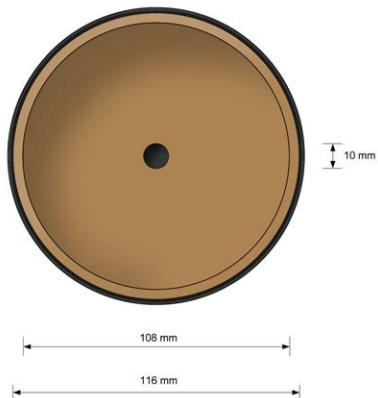

MATERIAL METAL 1.5 mm

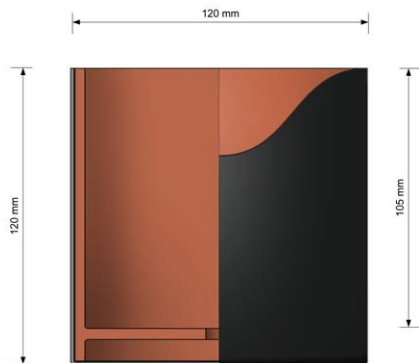

INNER POT IN CERAMIC MATERIAL

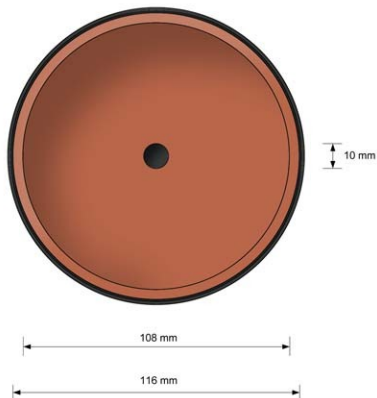

MATERIAL METAL 1.5 mm

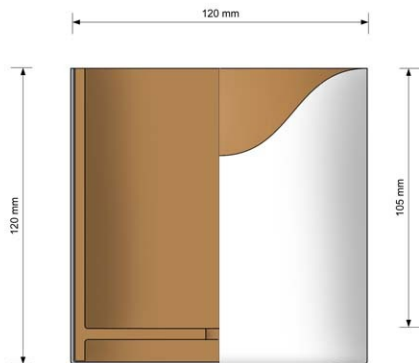

INNER POT IN CERAMIC MATERIAL

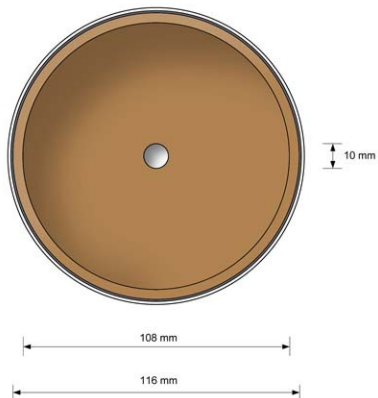

MATERIAL METAL 1.5 mm

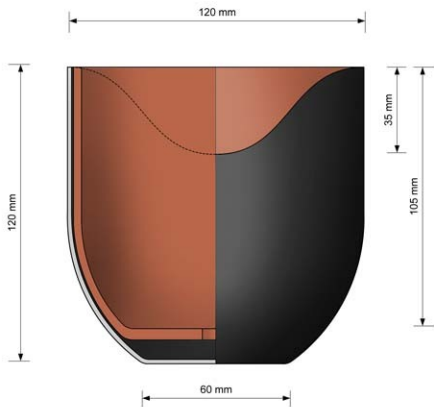

INNER POT IN CERAMIC MATERIAL

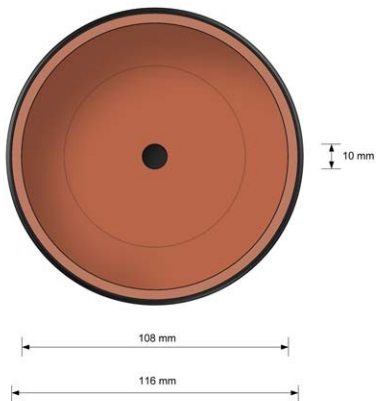

MATERIAL METAL 1.5 mm

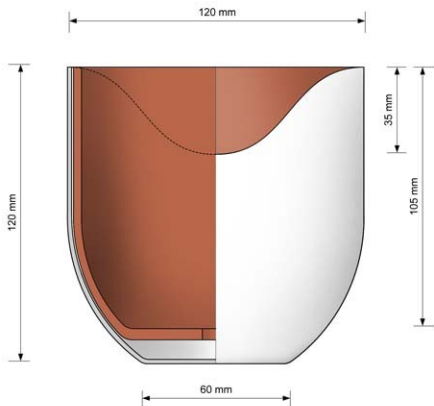

INNER POT IN CERAMIC MATERIAL

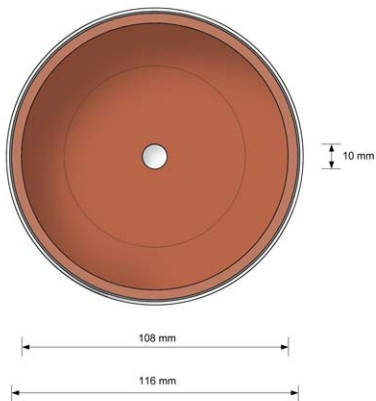

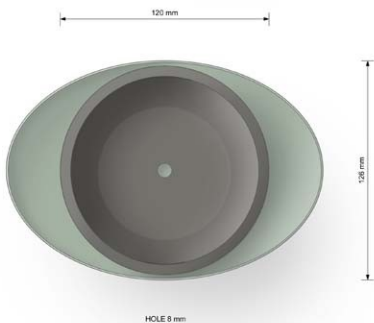
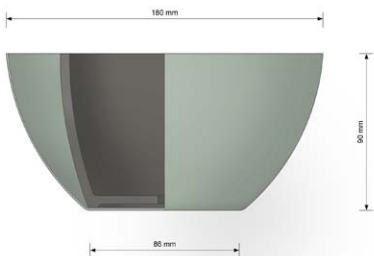

MATERIAL METAL 1mm / CERAMIC 6mm

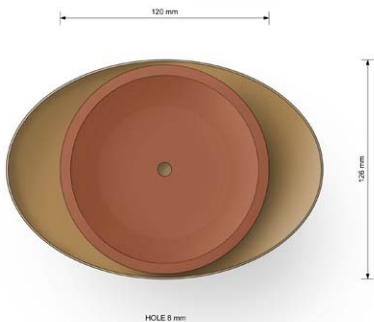
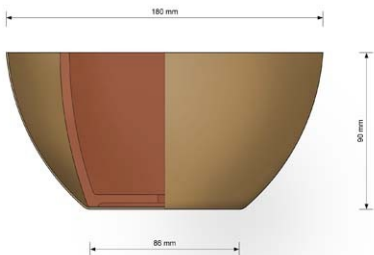

MATERIAL METAL 1mm / CERAMIC 6mm



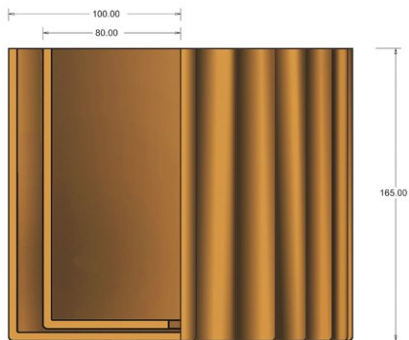

FLOWERPOT IN CERAMIC

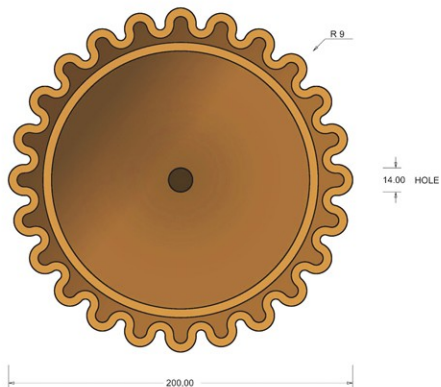

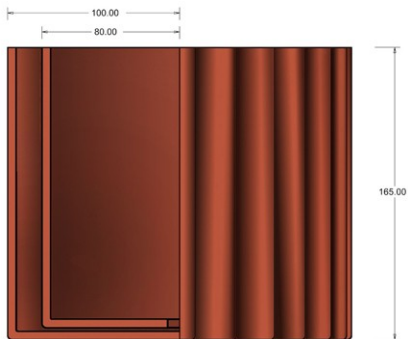

FLOWERPOT IN CERAMIC

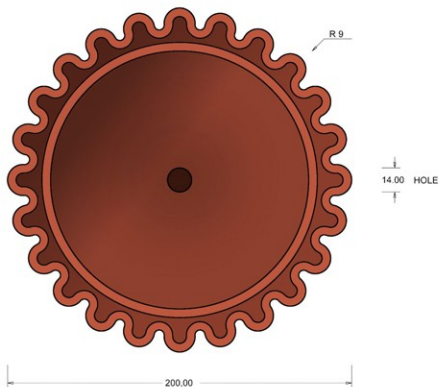



MATERIAL GLASS





MATERIAL GLASS



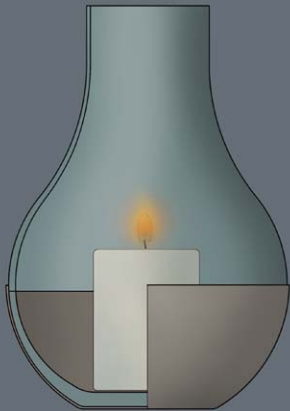

MATERIAL GLASS / METAL

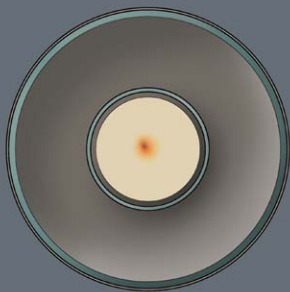

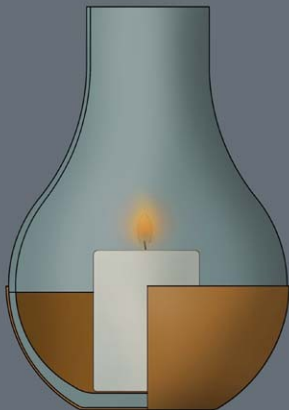

MATERIAL GLASS / METAL

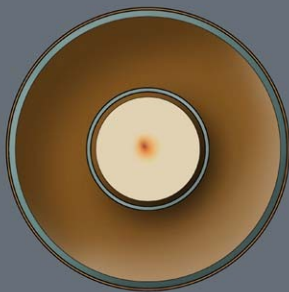

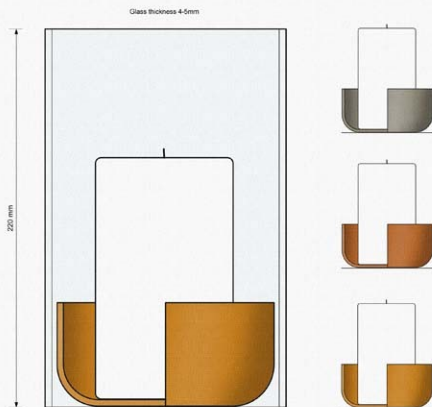

MATERIAL METAL GLASS

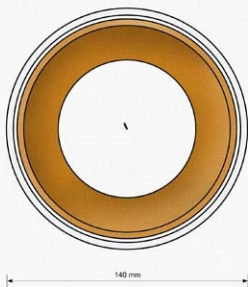

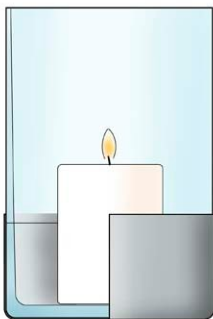

MATERIAL GLASS / METAL

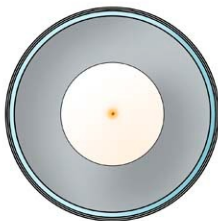



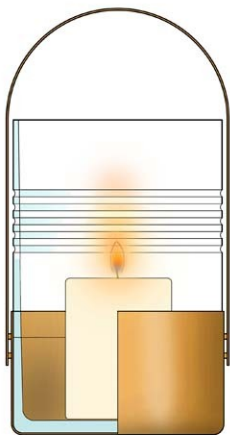

MATERIAL GLASS / METAL

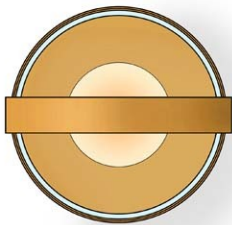

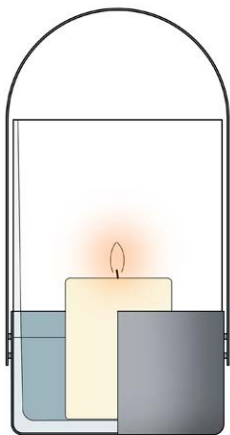

MATERIAL GLASS / METAL

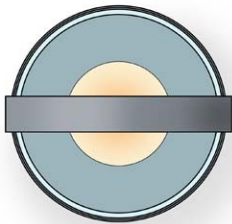

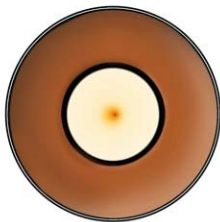
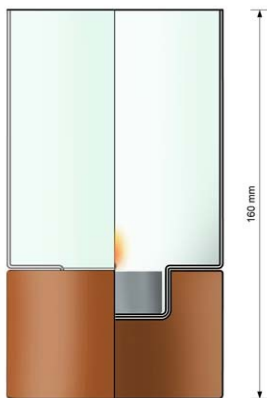

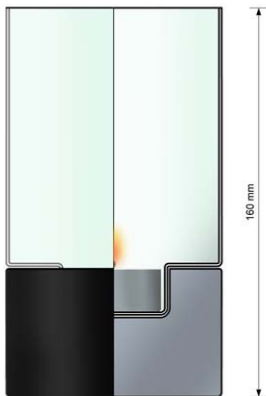

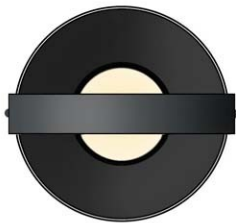
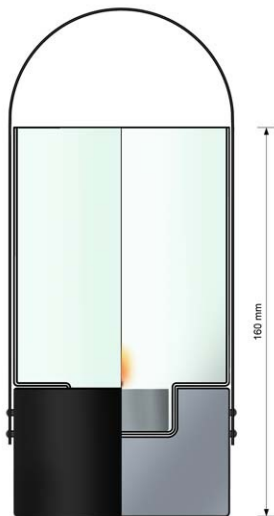

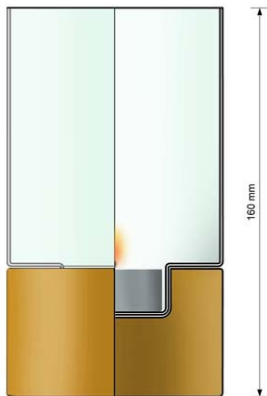



MATERIAL GLASS / METAL



124 mm



MATERIAL GLASS / METAL







MATERIAL GLASS / METAL



MATERIAL GLASS / METAL



MATERIAL GLASS / METAL

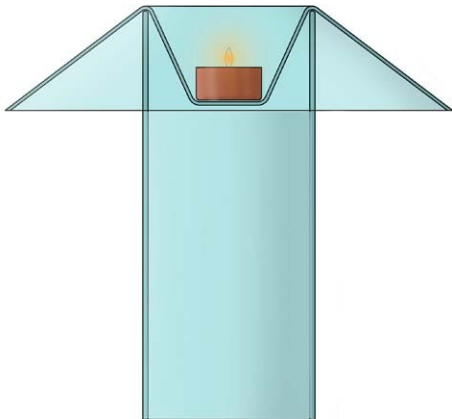

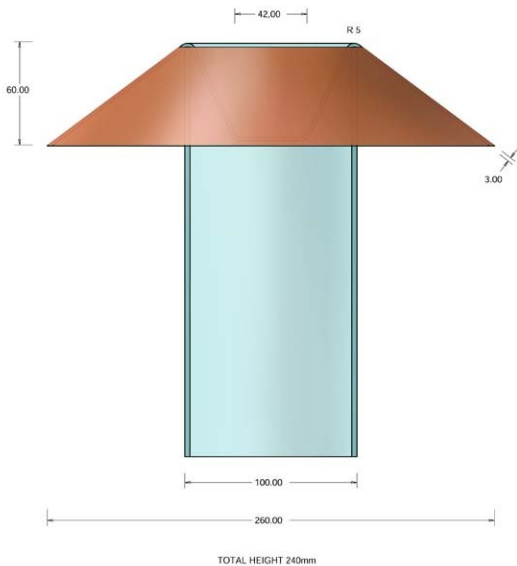

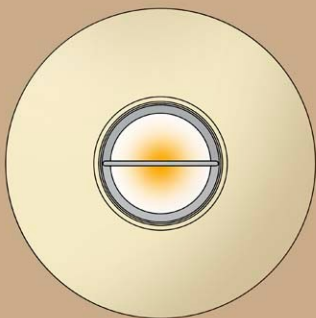
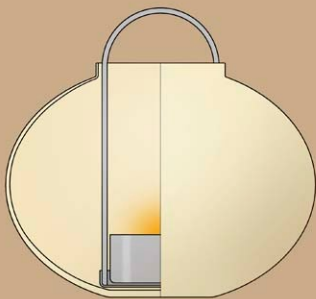

WHITE FROSTED GLASS ON CLEAR GLASS

STAINLESS STEEL HOLDER

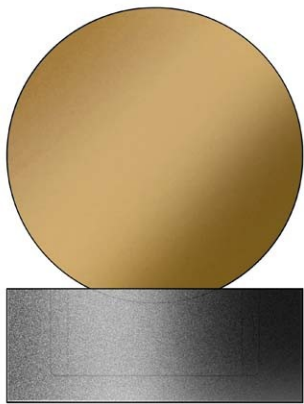

MATERIAL CONCRETE / METAL



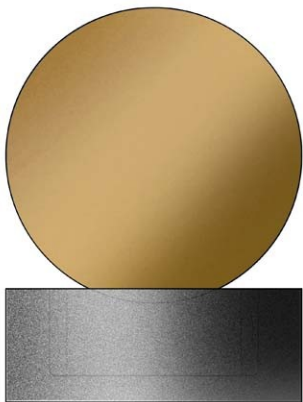

MATERIAL CONCRETE / METAL



REFILLABLE LAMP-OIL RESERVOIR



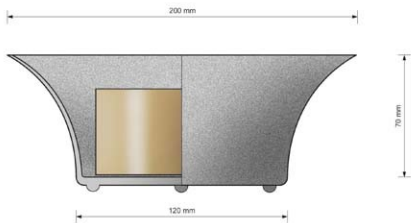

MATERIAL CAST METAL



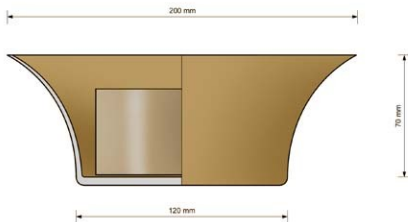

MATERIAL CAST METAL

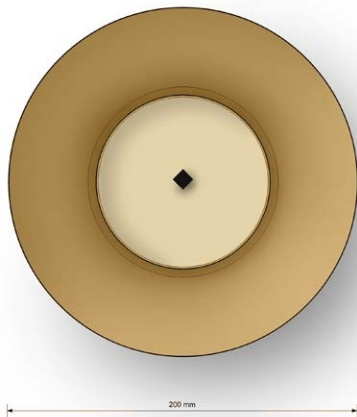

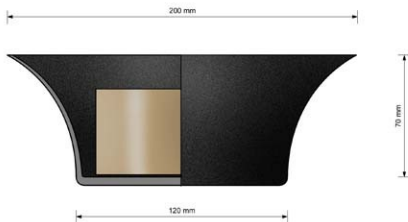

MATERIAL CAST METAL





MATERIAL CERAMIC



HOLE: 110x105x55mm



MATERIAL CERAMIC

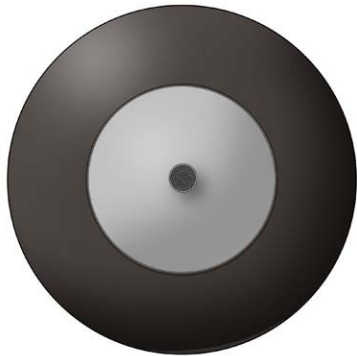

HOLE: 110x105x55mm



MATERIAL METAL



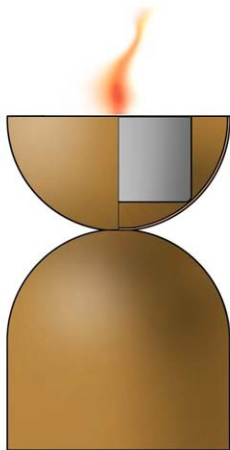

MATERIAL METAL

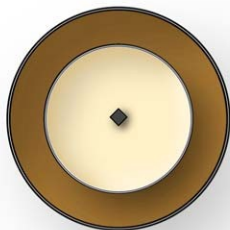

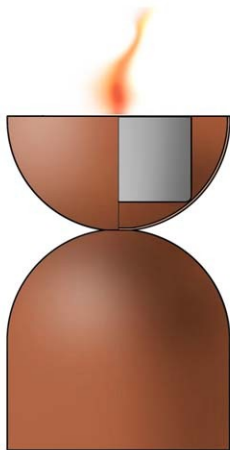

MATERIAL METAL





SIDE TABLE IN METAL

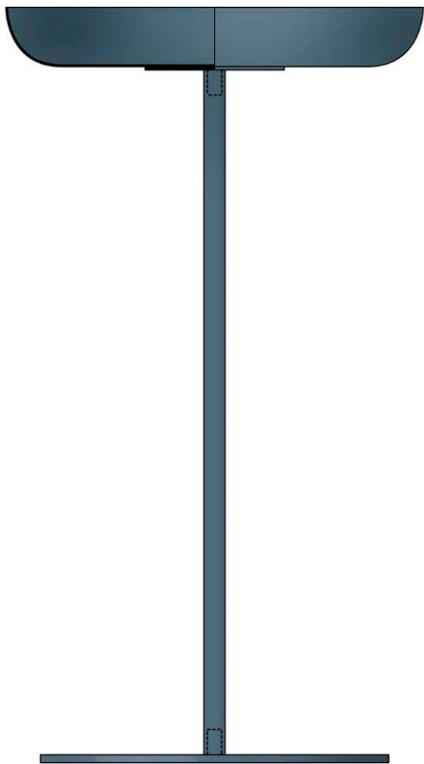

SIDE TABLE IN METAL



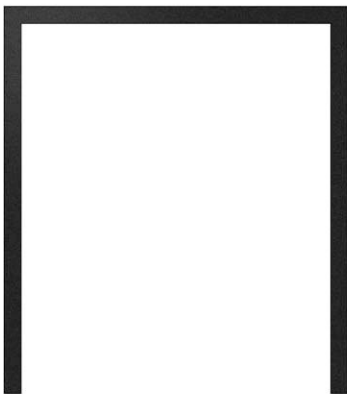

STOOL IN CONCRETE 450x400x400

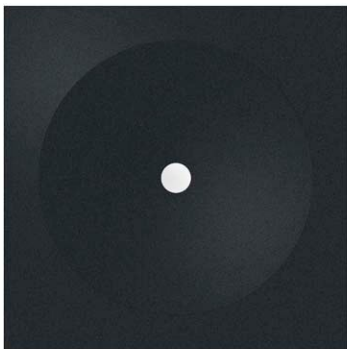

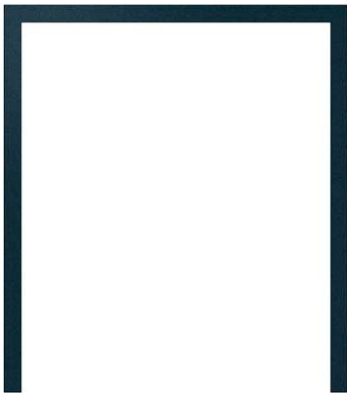

STOOL IN CONCRETE 450x430x400

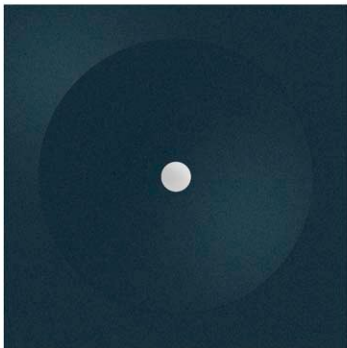

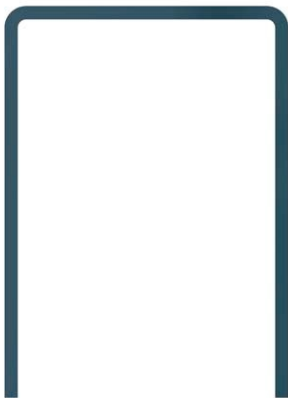

MATERIAL STEEL SHEET

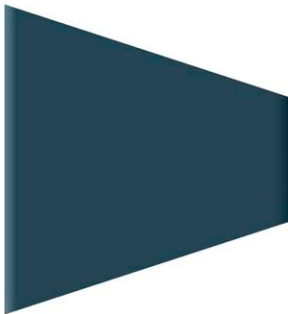

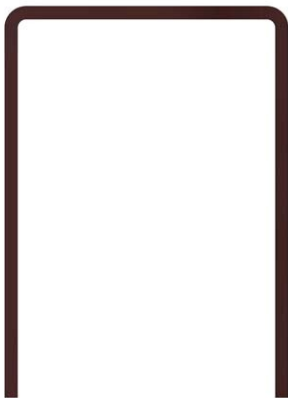

MATERIAL STEEL SHEET

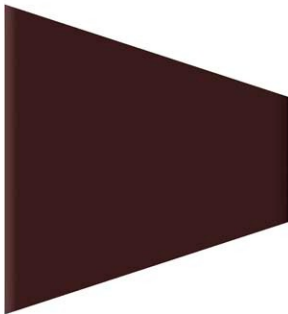

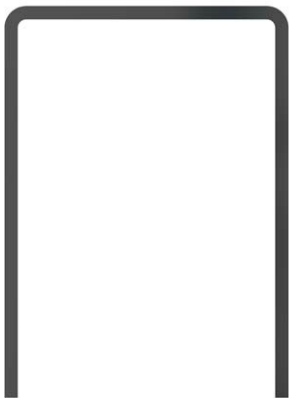

MATERIAL STEEL SHEET



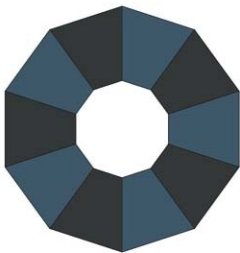
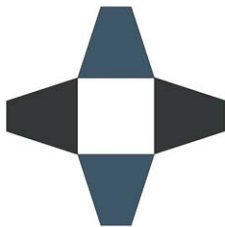



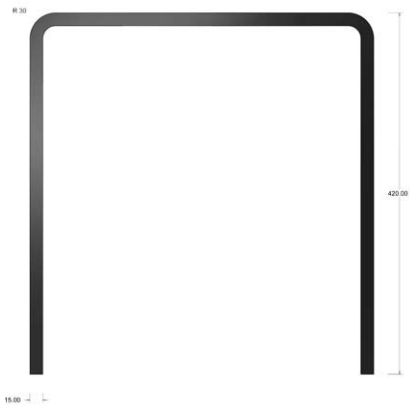

TABLE IN LAMINATED WOOD

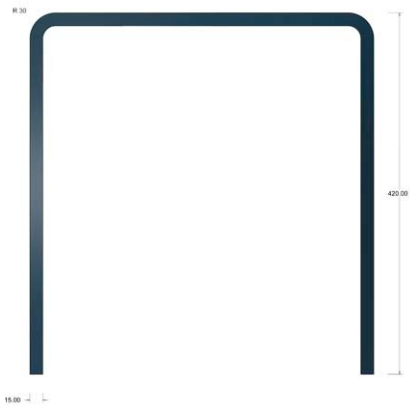
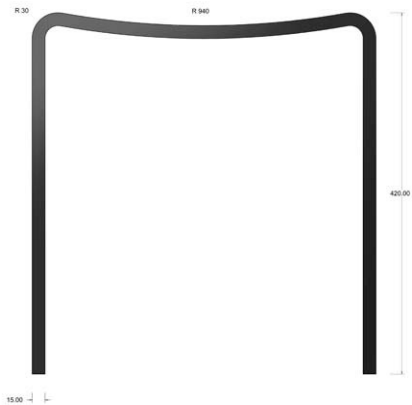
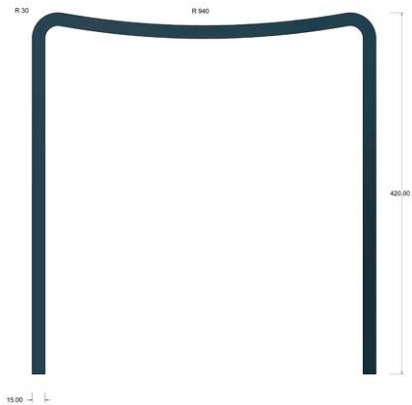

TABLE IN LAMINATED WOOD



STOOL IN LAMINATED WOOD



STOOL IN LAMINATED WOOD



TABLE IN WOOD

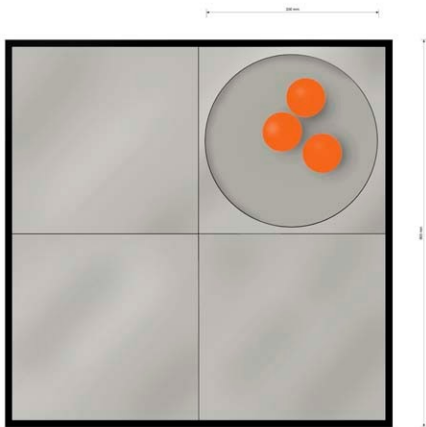

MATERIAL: WOOD 24x20mm



TABLE FRAME

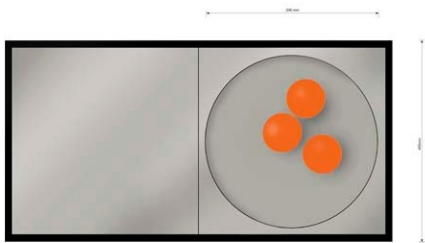

TABLETOP, WOOD SURFACE



TABLE IN WOOD

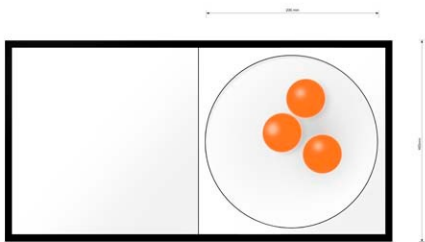

SECTIONAL VIEW OF TABLE



TABLE IN WOOD

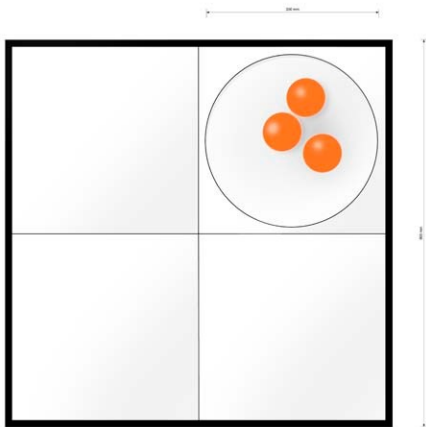

MATERIAL: WOOD 20x20mm





MATERIAL: 15mm WOOD / 10mm STEEL TUBE

SCALE 1:2

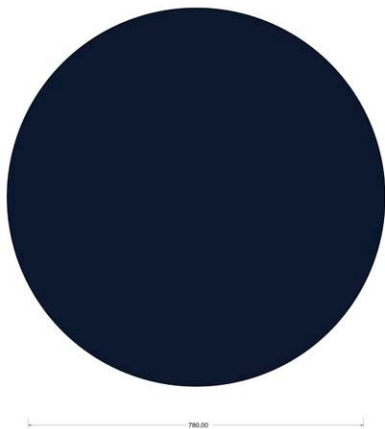



MATERIAL: 15mm WOOD / 10mm STEEL TUBE

SCALE 1:2

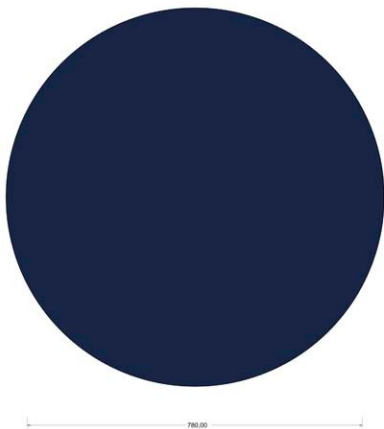

STOOL FOOTREST

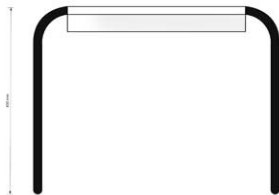

MATERIAL METAL TUBE 20mm x TEXTILE

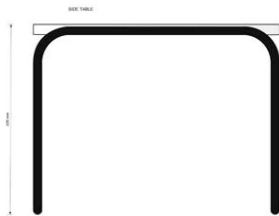

BOX TABLE

MATERIAL METAL TUBE 20mm x CORIAN



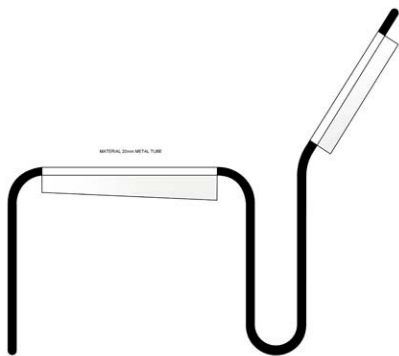

OUTDOOR CHAIR IN METAL / TEXTILE MATERIAL

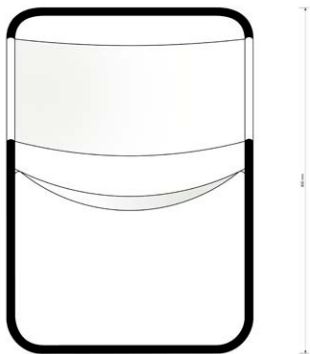

OUTDOOR CHAIR FRONT VIEW

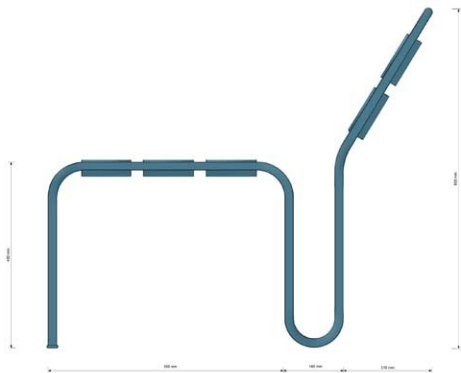

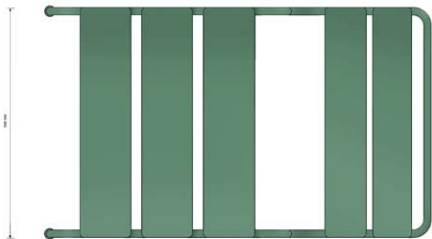
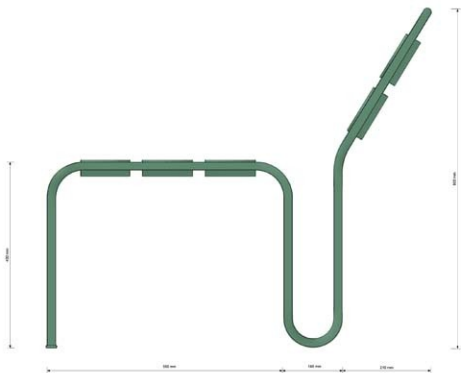

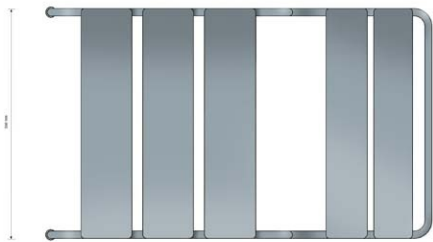
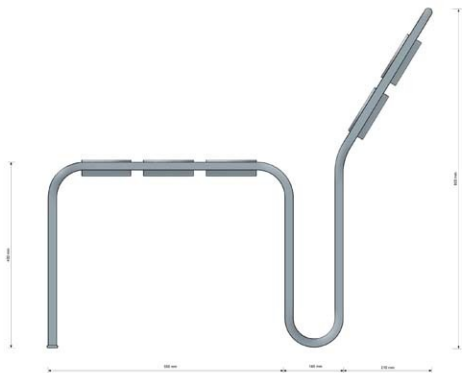

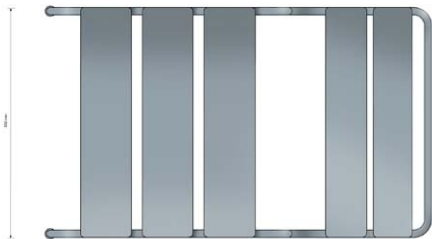
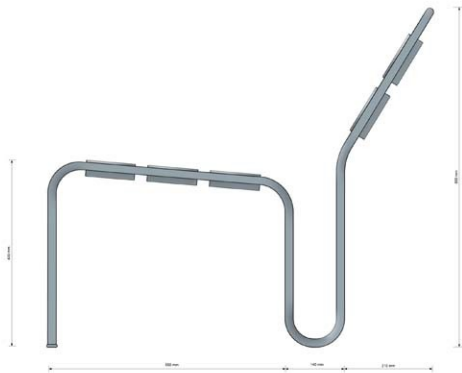



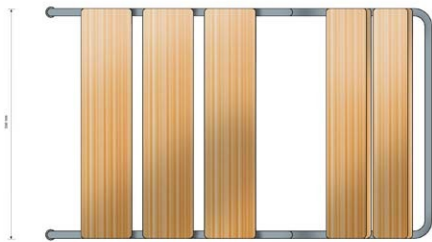
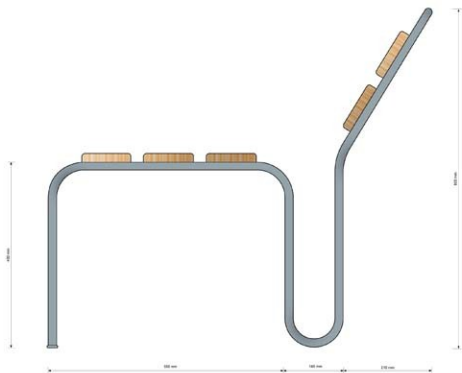

FLOWER STAND / SHELF

2016-12-08  
Design: Miguel Luyten  
Material: 20x25x0.5mm 304 stainless steel  
Copyright

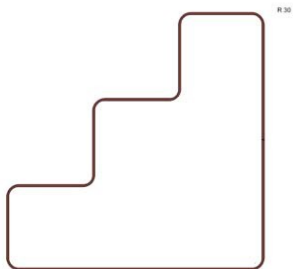

MATERIAL METAL

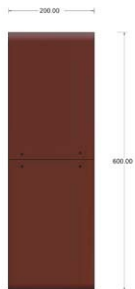

SCALE 1:2

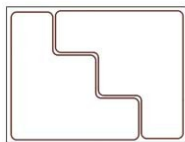
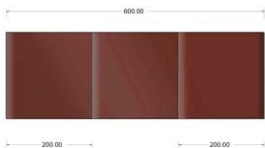

PACKAGE

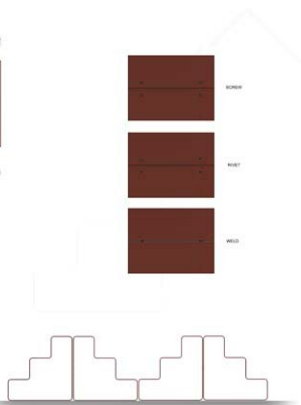

# FLOWER STAND / SHELF

2021-02-08  
Design: Richard L. Taylor  
Illustration: JONATHAN BUCKLE  
Español

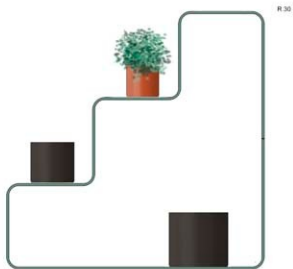

MATERIAL METAL

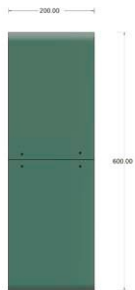

SCALE 1:2

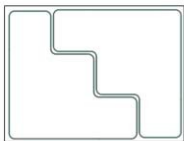
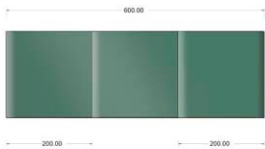

PACKAGE

# FLOWER STAND / SHELF

2016 - 2018  
Design: Robert Langner  
Production: CANTIERE DESIGN  
Espagna

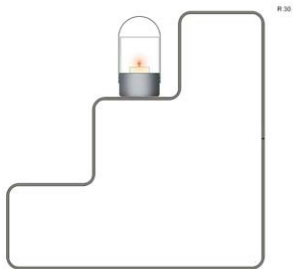

MATERIAL METAL



SCALE 1:2

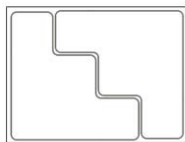
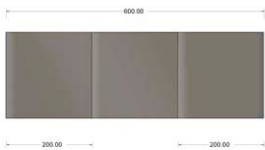

PACKAGE



FLOWER STAND / SHELF

2016 - 2018  
Design: Filippo Leijer  
Material: COTON (P&G) (2016)  
Copenhagen

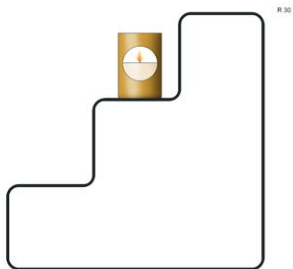

MATERIAL METAL 10mm

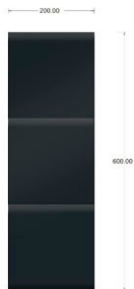

SCALE 1:2

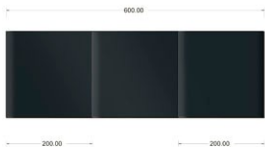

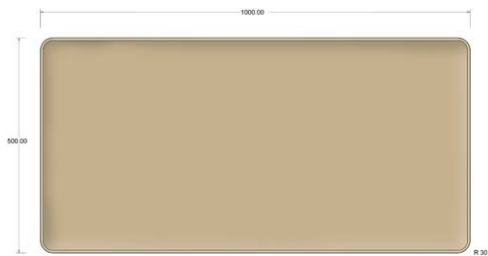

TABLE WITH METAL STAND

SCALE 1:2



HOLE FOR DRAINAGE







Thank you for looking.

The presentations should be regarded as the beginning of a creative dialogue, between producer and designer.

For more info contact:

[info@magnuslofgrendesigns.se](mailto:info@magnuslofgrendesigns.se)