

Welcome to the MLD archive
for product developers.

© MLD Studio

Click, swipe or scroll to start slideshow.

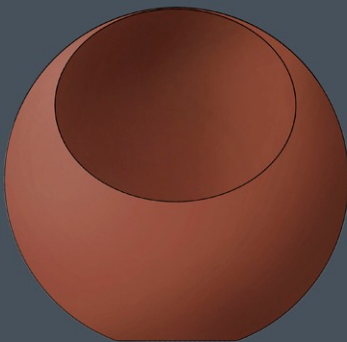

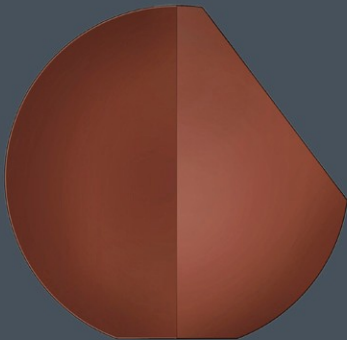

MATERIAL METAL 2mm / WOOD 20mm

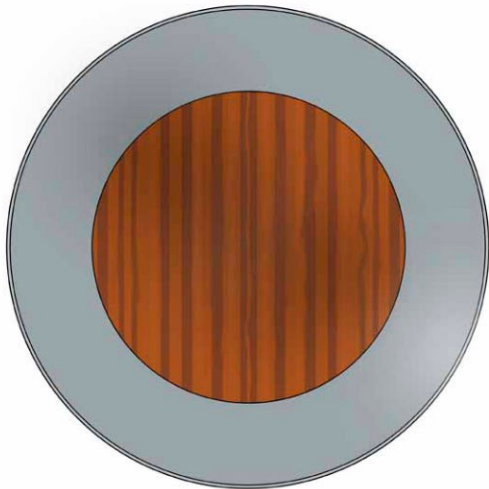

CHEESE TRAY

2020-01-21

Design Magnus Liljeqvist
MAGNUS LILJEQVIST DESIGN

CHEESE TRAY IN WOOD

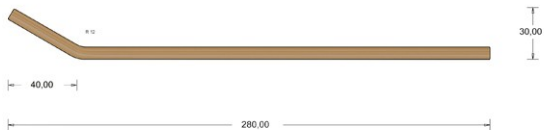

MATERIAL WOOD 7mm

SOFT EDGES

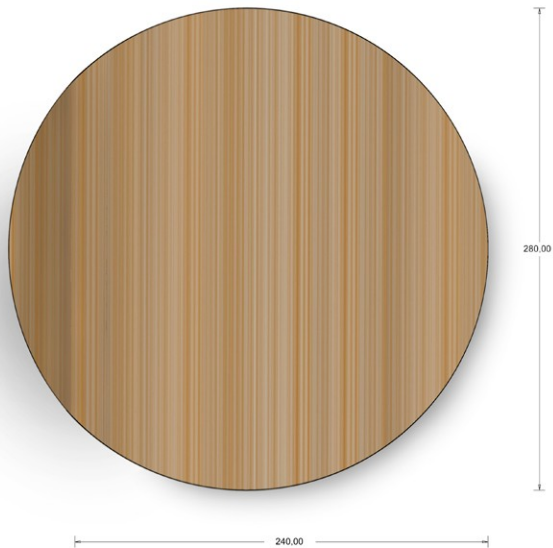

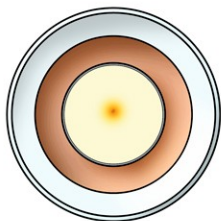
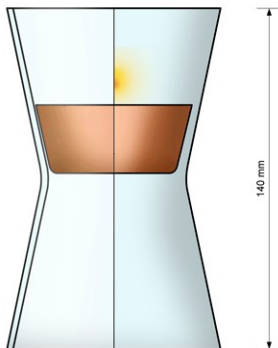

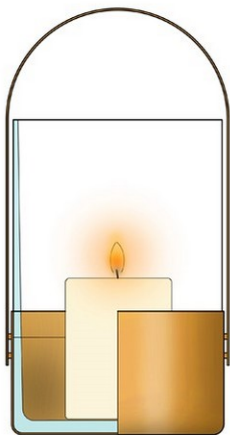

MATERIAL GLASS / METAL

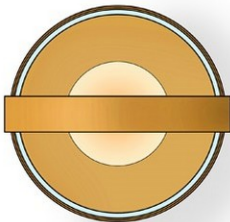

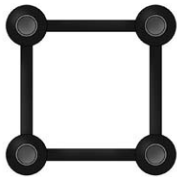
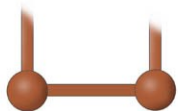
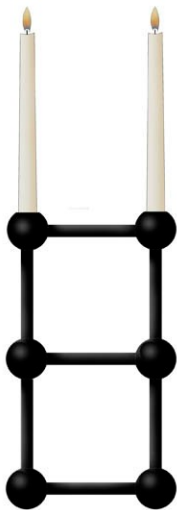

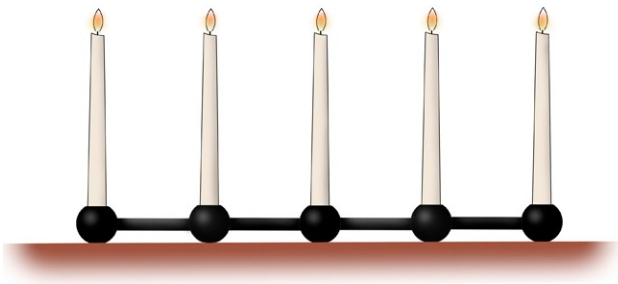

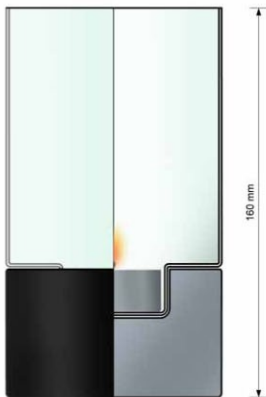

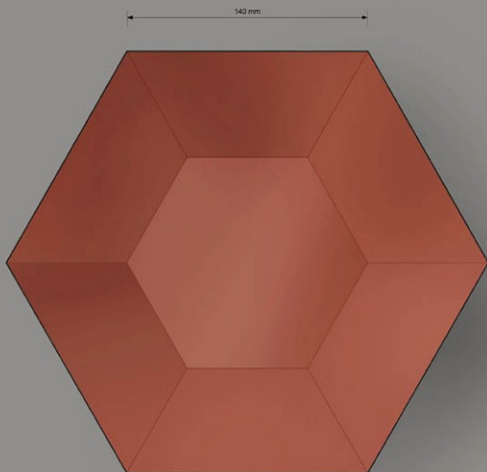
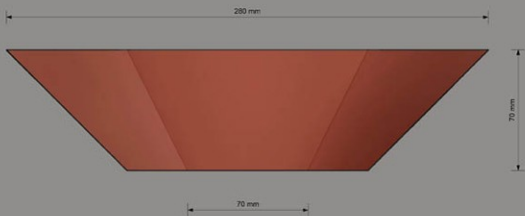



WALL

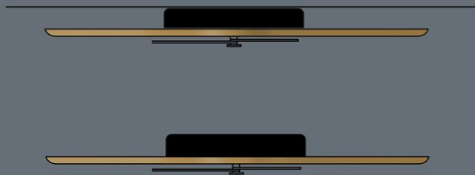

MATERIAL METAL

BOTTLE OPENER

2004-03-17

Design: Magnus Lofgren
MAGNUS LOFGREN DESIGNS

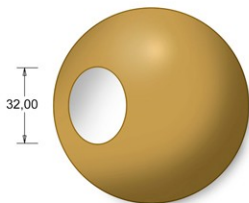

24,00

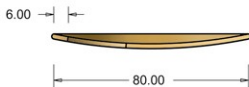

A-A CUT VIEW

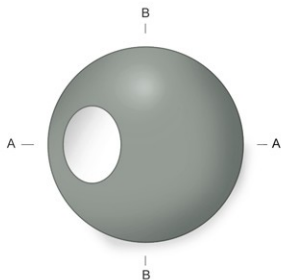

B-B CUT VIEW

MATERIAL STAINLESS STEEL

MODEL B WITH STRING

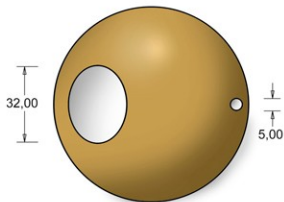

24,00

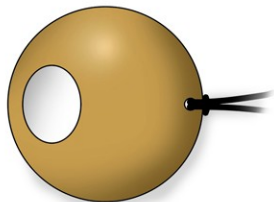

RUBBER STRING 3mm

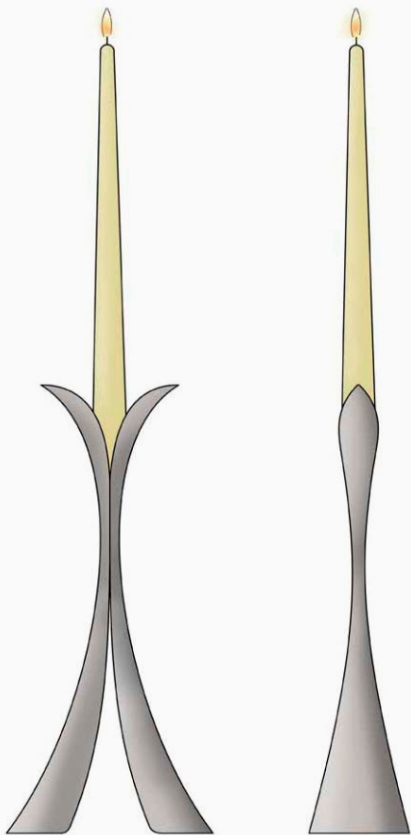

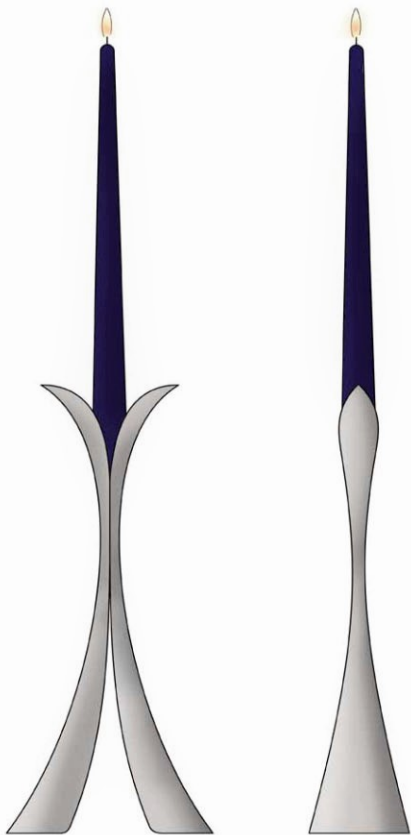

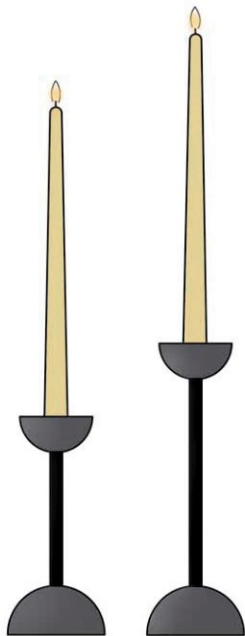

MATERIAL WOOD / METAL

CANDLEHOLDER WOOD / METAL
2011-04-25
MAGNUS LÖFGREN DESIGNS
Design: Magnus Löfgren
Copyright

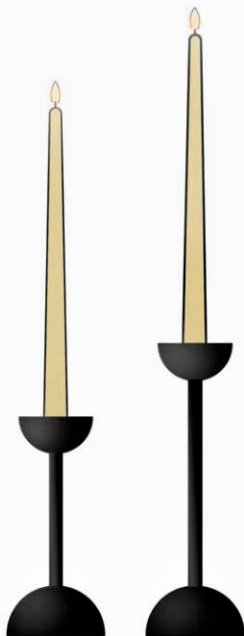

MATERIAL WOOD / METAL

METAL/GLASS WINDLIGHT

2002-11-27

Design: Magnus Lofgren

MAGNUS LOFGREN DESIGNS

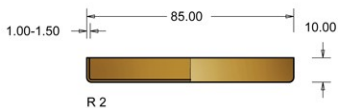
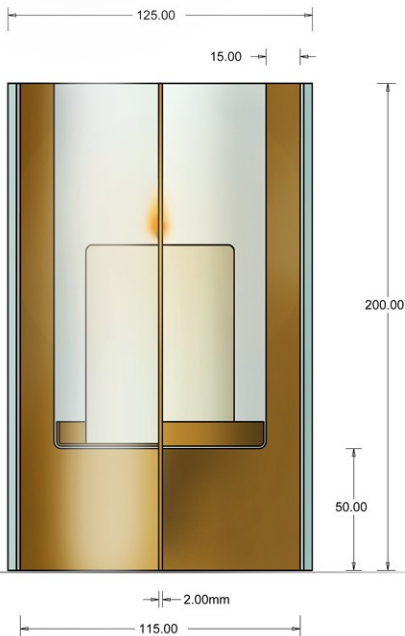

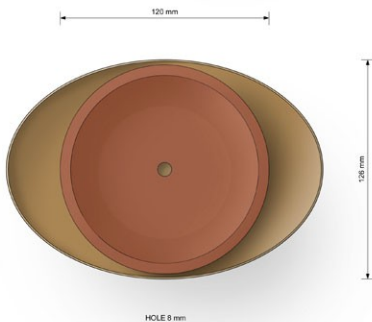
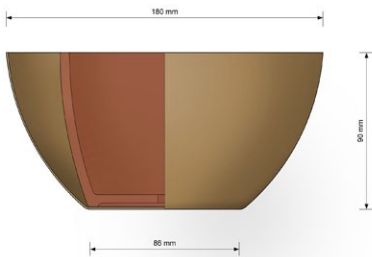

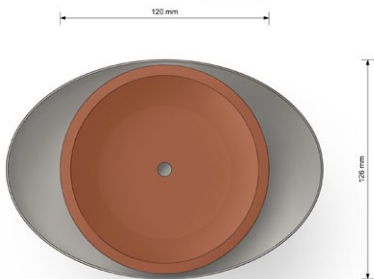
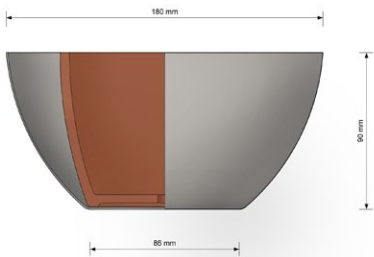

HOLE 8 mm

MATERIAL METAL 1mm / CERAMIC 6mm

MATERIAL METAL 1.5 mm

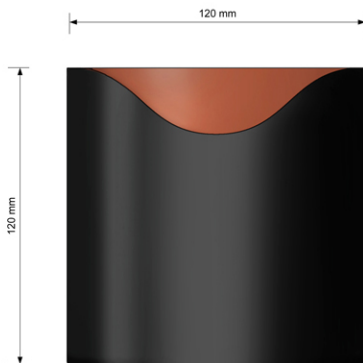

INNER POT IN CERAMIC MATERIAL

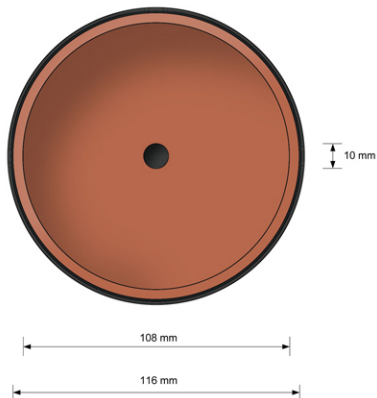

MATERIAL METAL 1.5 mm

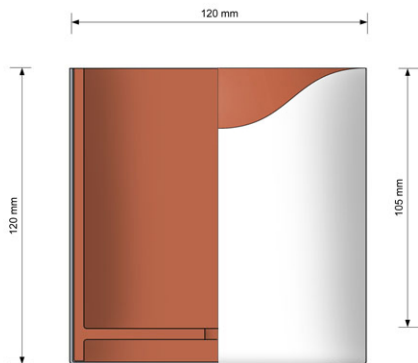

INNER POT IN CERAMIC MATERIAL

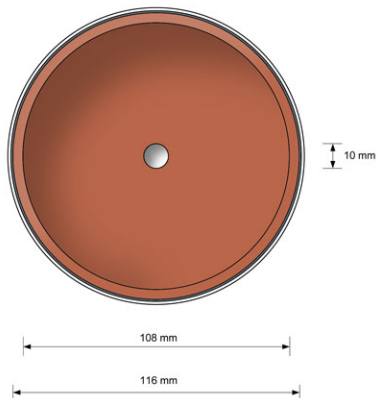

MATERIAL METAL 1.5 mm

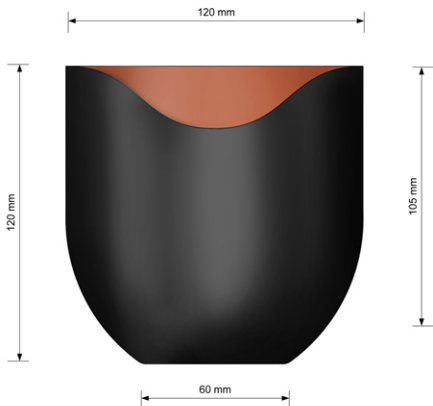

INNER POT IN CERAMIC MATERIAL

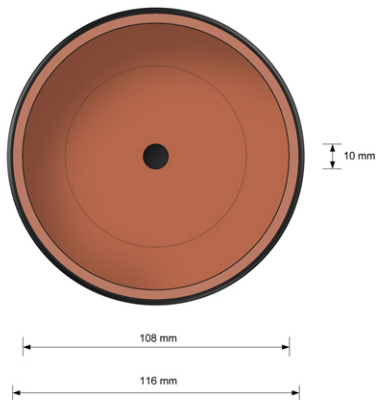

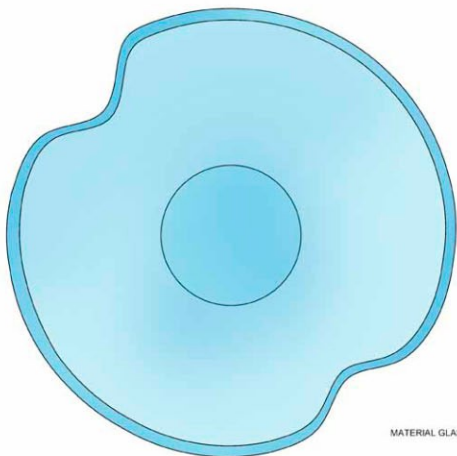
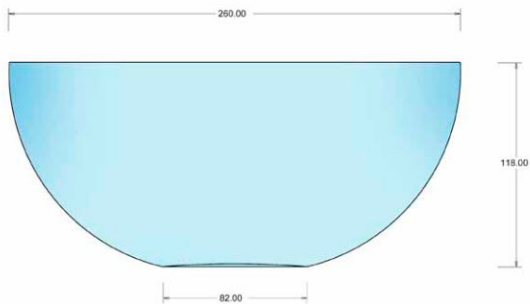

MATERIAL GLASS



MATERIAL GLASS



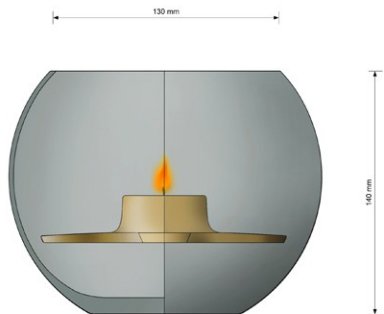

MATERIAL GLASS / METAL

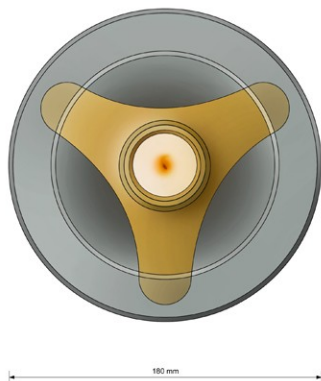

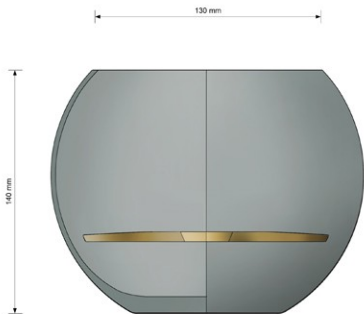

MATERIAL GLASS / METAL



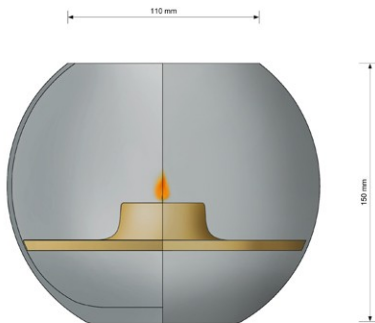

MATERIAL GLASS / METAL

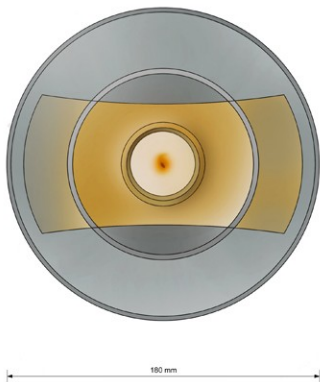

MATERIAL GLASS / METAL

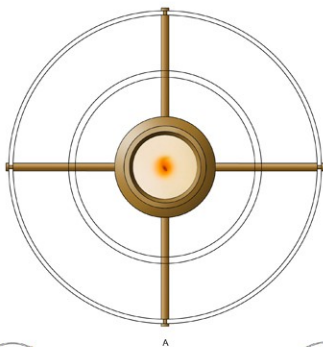
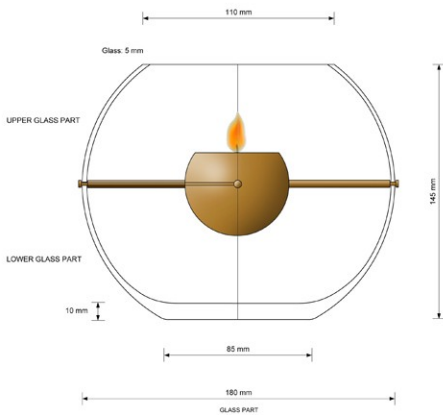

METAL PART ON SEPARATE DRAWING



MATERIAL GLASS / METAL

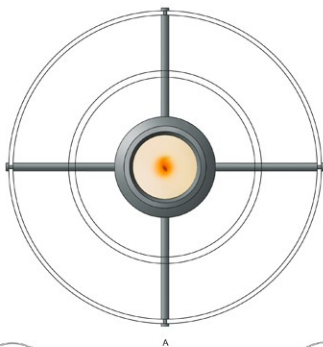
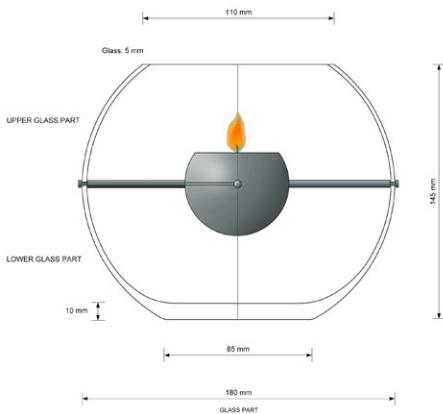

METAL PART ON SEPARATE DRAWING



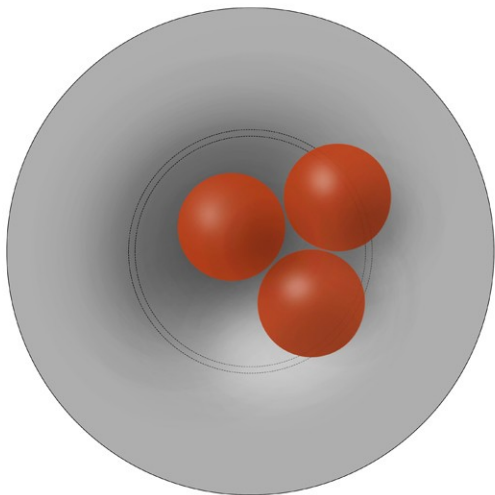
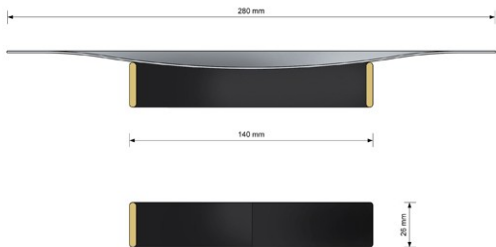

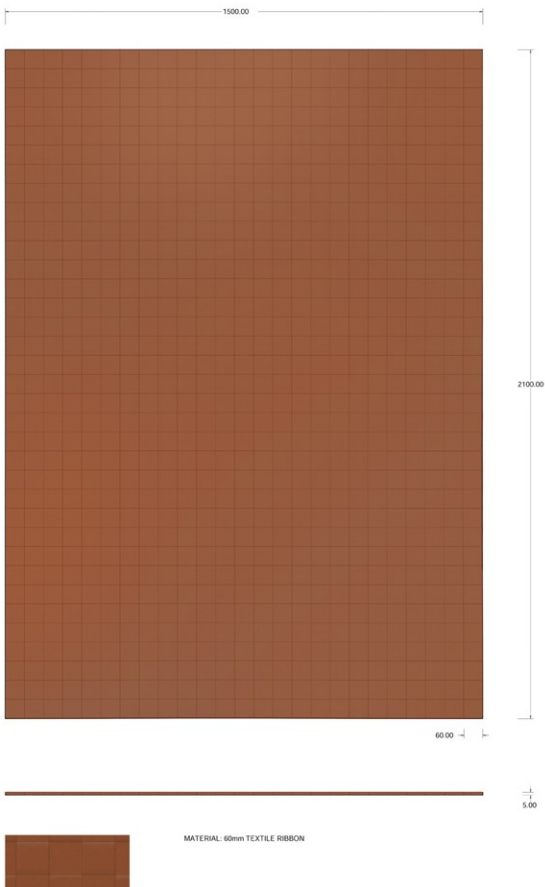

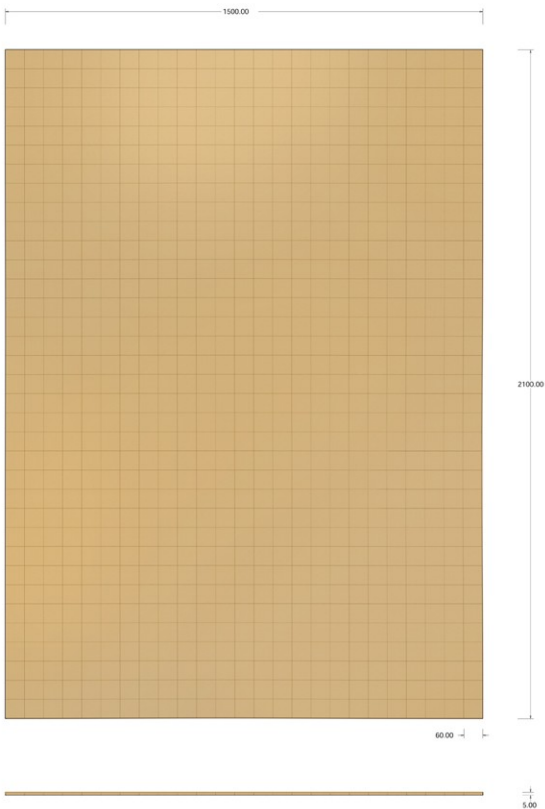

THREE BOWLS

2003-08-16
Design Magnus Löfgren
MAGNUS LOFGREN DESIGNS

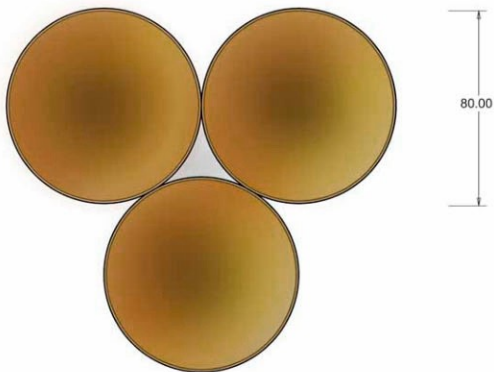
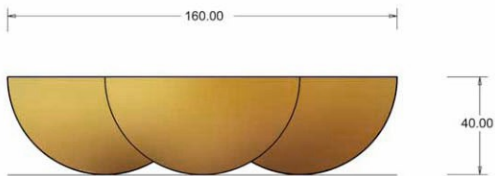

The pieces should be mounted together using welding or soldering.

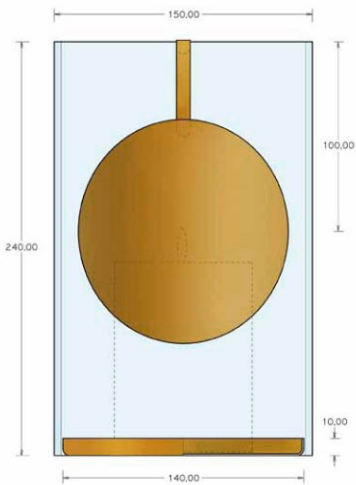

DIAMETER OF MIRROR 130mm

MATERIAL GLASS 4mm / METAL 1mm

8,00

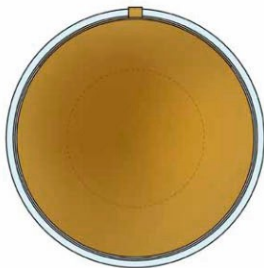

80,00

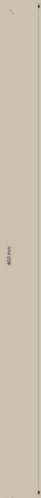
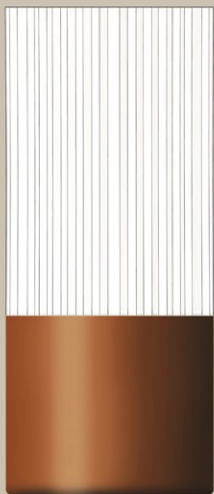

MATERIAL: METAL / PLASTIC (PAPER)

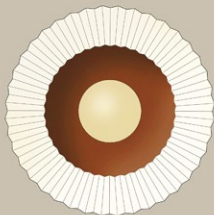

CANDLEHOLDER

2006-10168
Design: Magnus Löfgren
MAGNUS LOFGREN DESIGNS

MATERIAL METAL



100,00

26,00



70,00

CANDLEHOLDER

2004-10168

Design: Magnus Löfgren

MAGNUS LOFGREN DESIGNS

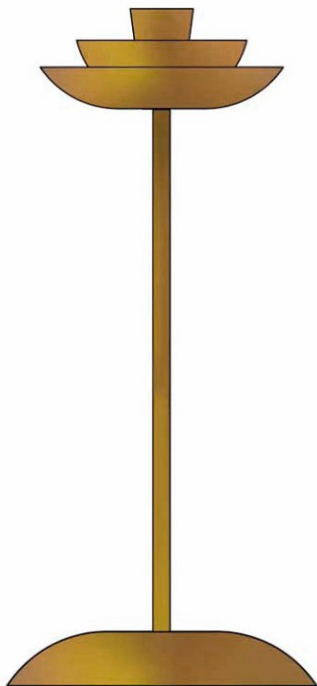

MATERIAL METAL

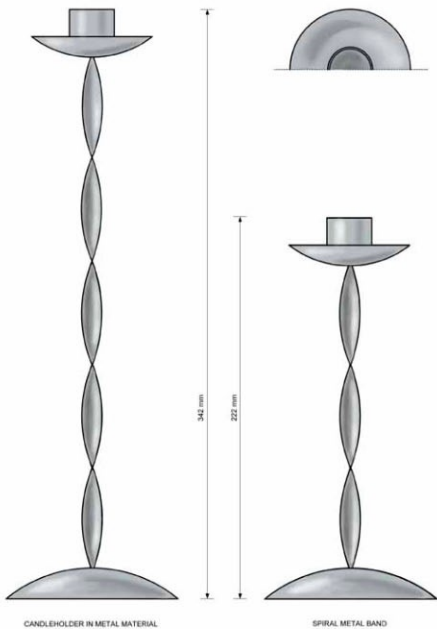

CANDLEHOLDER IN METAL MATERIAL

SPIRAL METAL BAND

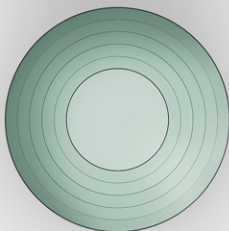
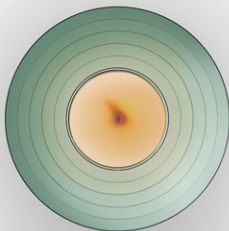

42 mm

92 mm



MATERIAL GLASS / METAL





MATERIAL GLASS

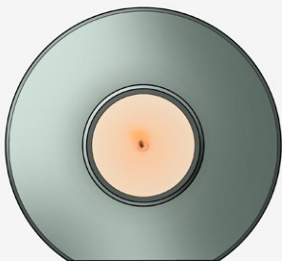

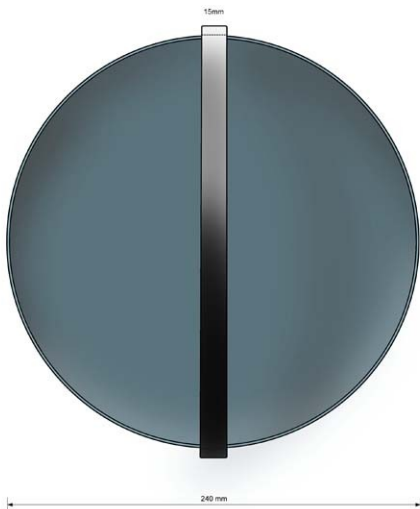
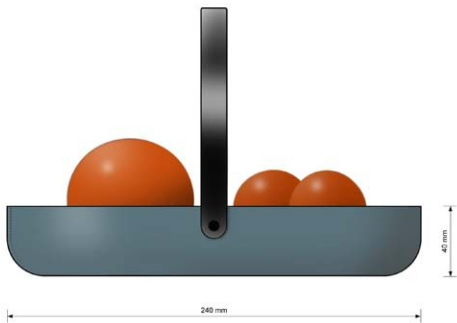

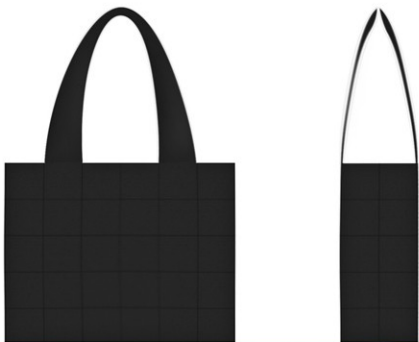

MATERIAL: 60mm TEXTILE RIBBON

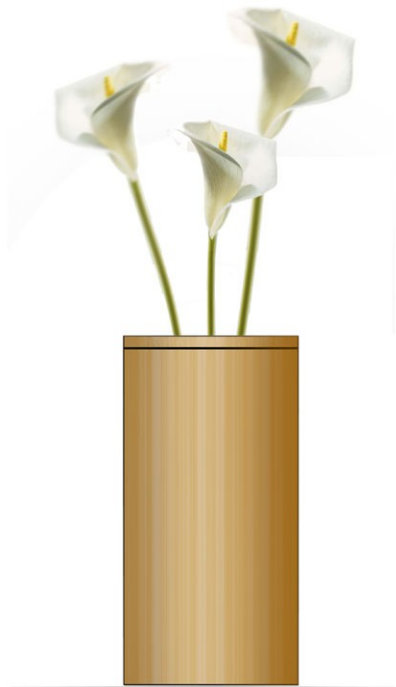



GLASS VASES WITH METAL LID

2004 02 08

Design: Magnus Lyngbo
Material: GLASS (100%) / METAL (10%)

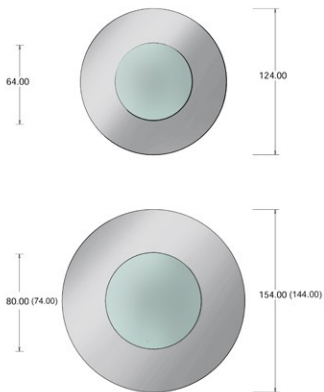
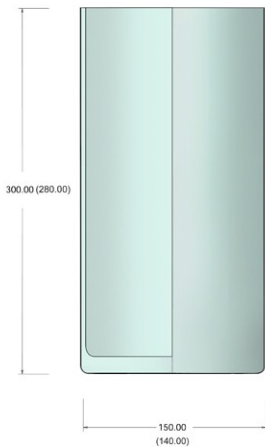
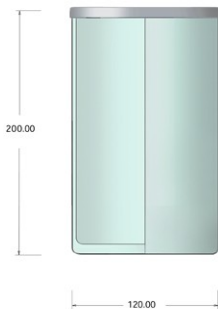

GLASS VASES WITH METAL LID

2004-01-28

Design: Magnus Lidgren
Material: VIKO glass, BK 33380

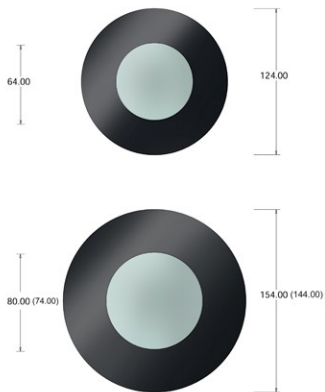
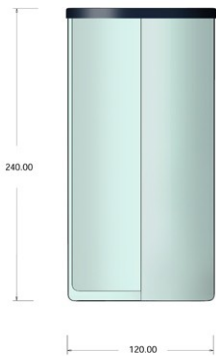
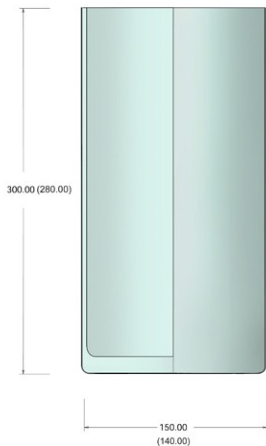
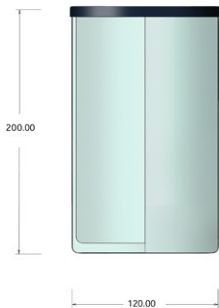

CLOCK IN METAL MATERIAL

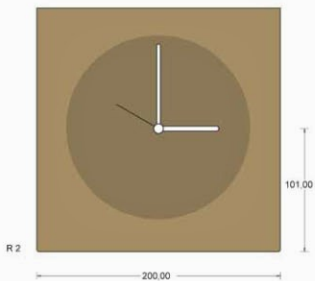

THICKNESS OF MATERIAL 1mm

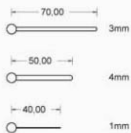
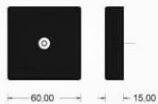

CLOCK IN METAL MATERIAL



THICKNESS OF MATERIAL 1mm

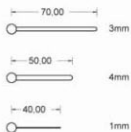
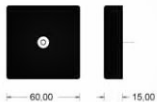
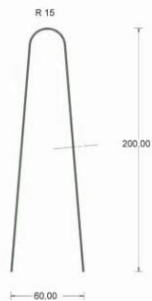

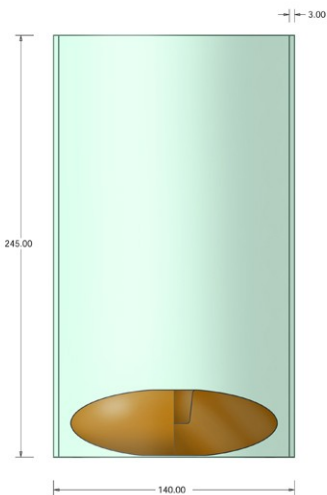

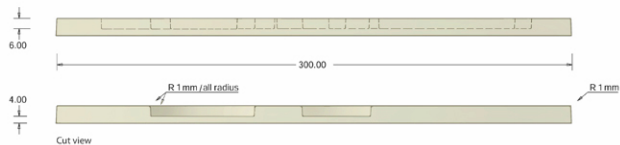

BOTTOM DIAMETER HOLES 42 / 62 / 82 / 122mm

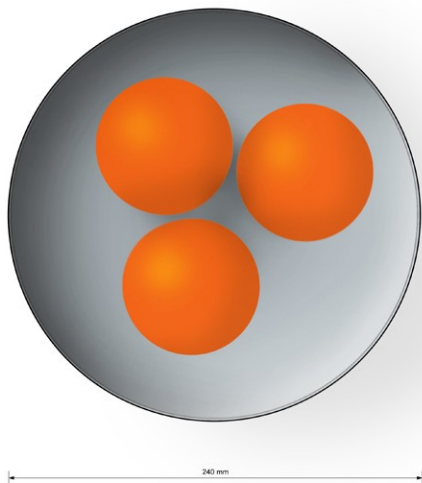
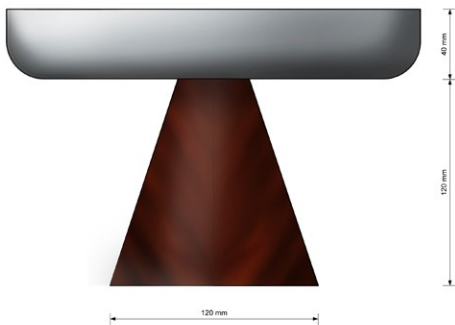

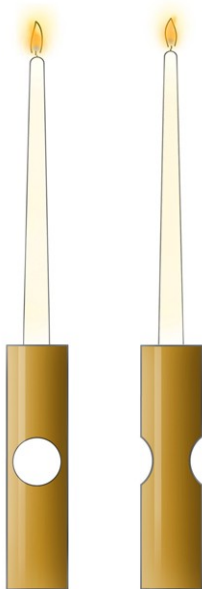

MATERIAL METAL

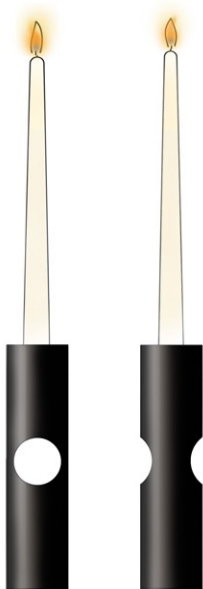

MATERIAL METAL

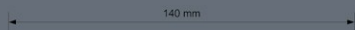
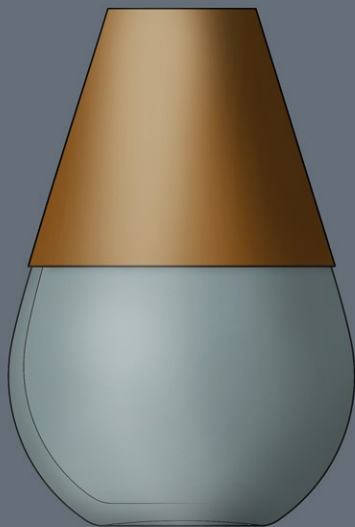

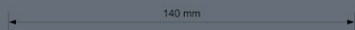
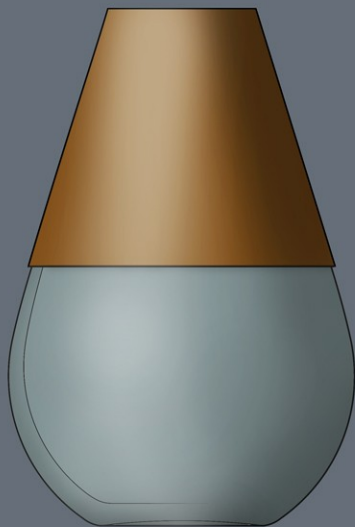

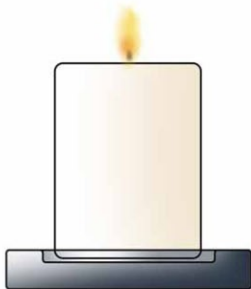

CAST GLASS



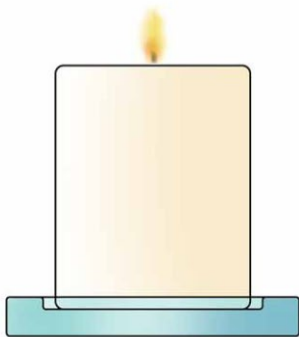

CAST GLASS

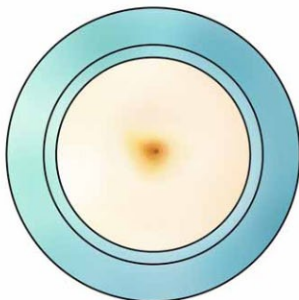

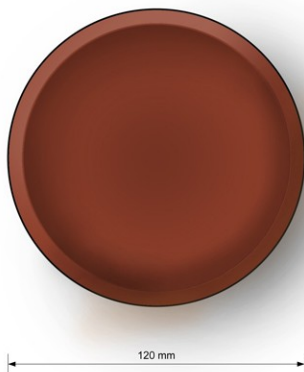

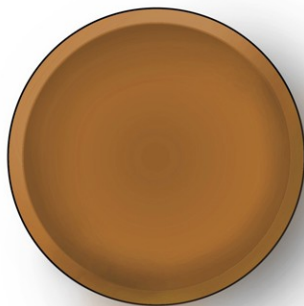

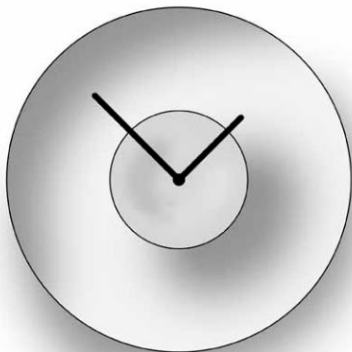

MATERIAL GLASS METAL



RUBBER COVER



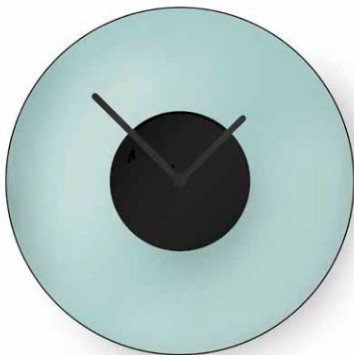

MATERIAL GLASS METAL



RUBBER COVER



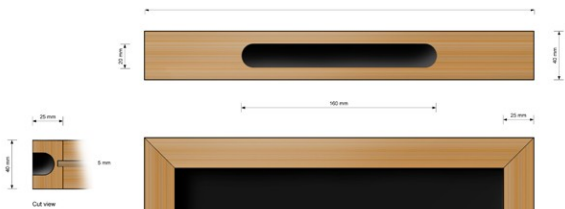

MATERIAL WOOD





MATERIAL: CAST METAL



MATERIAL: CAST METAL



MATERIAL: CAST METAL

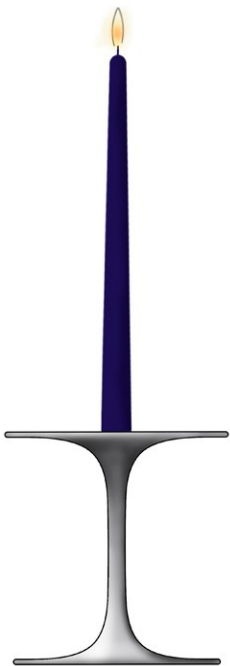

MATERIAL CAST METAL

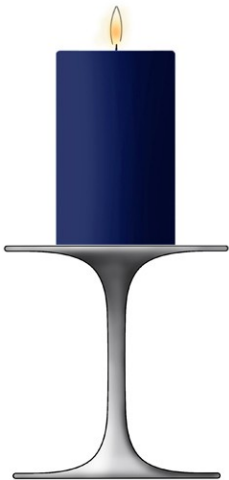

MATERIAL CAST METAL

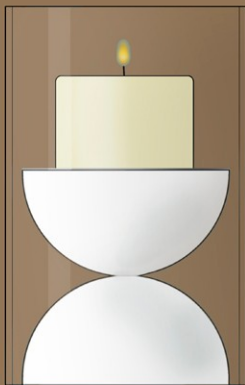

MATERIAL METAL 1mm / GLASS 4mm

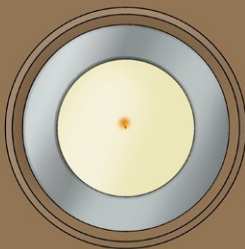

CANDLESTAND METAL
2016-02-01 (2011-01-12)
MAGNUS LÖFGREN DESIGNS
Design: Magnus Löfgren
Copyright

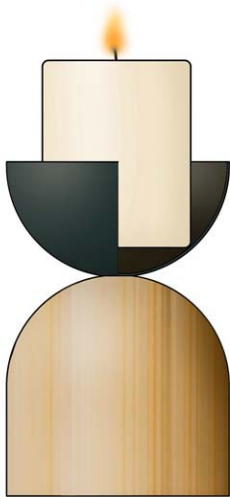

MATERIAL METAL / WOOD



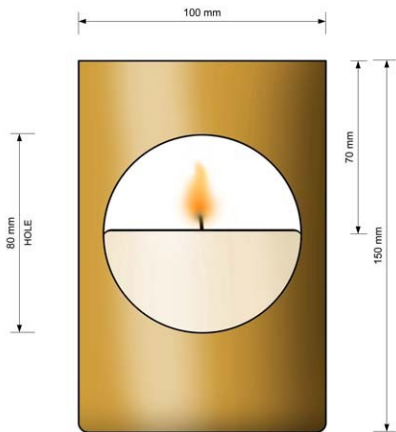

MATERIAL METAL 1mm

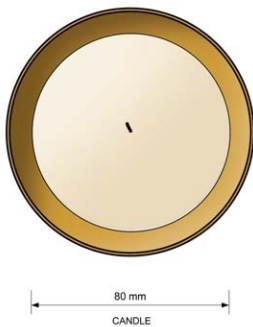

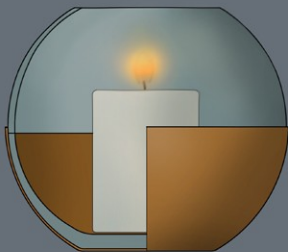

MATERIAL GLASS / METAL

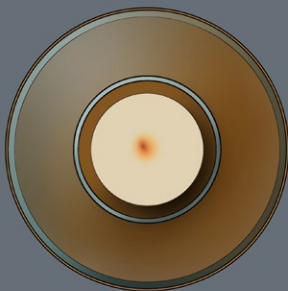

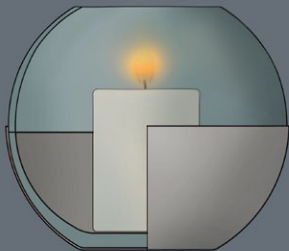

MATERIAL GLASS / METAL

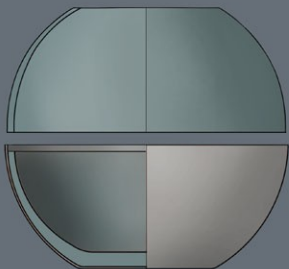

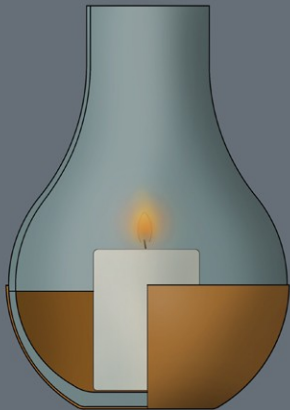

MATERIAL GLASS / METAL

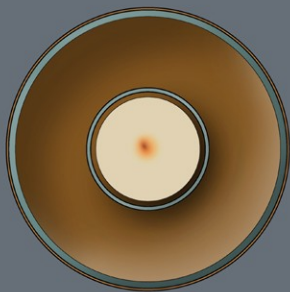

250mm



320mm



380mm



BOWLS IN GLASS MATERIAL

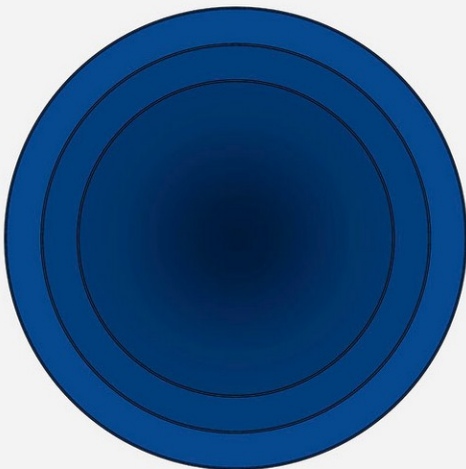

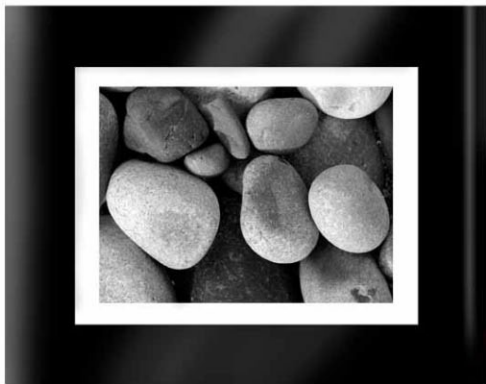

A



B



Hanging on wall



Standing

MATERIAL METAL / PLASTIC



14 mm

280 mm

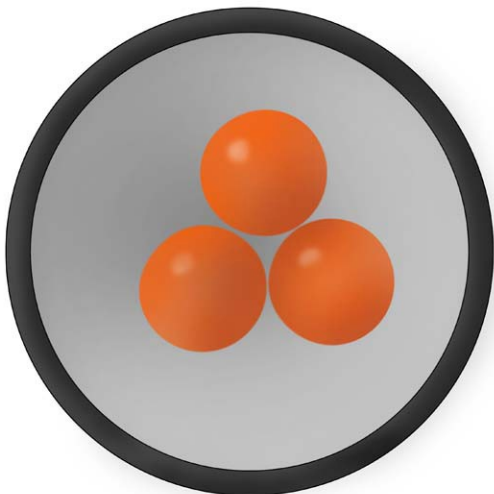

MATERIAL METAL / PLASTIC



14 mm



280 mm



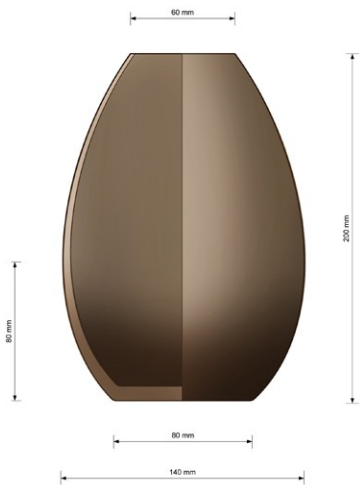

MATERIAL GLASS



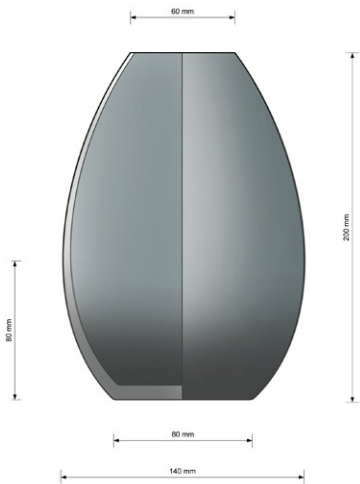

MATERIAL GLASS

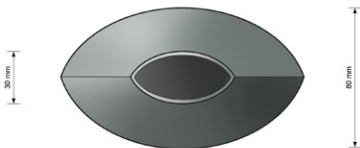



MATERIAL METAL 1mm



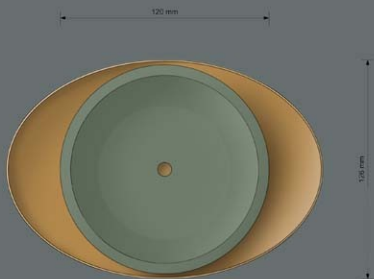
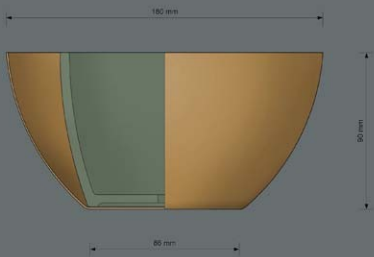

HOLE 8 mm

MATERIAL METAL 1mm / CERAMIC 6mm



WINE BOTTLE STAND IN SOLID WOOD



SCALE 1:2

MATERIAL: WOOD

SCALE 1:1

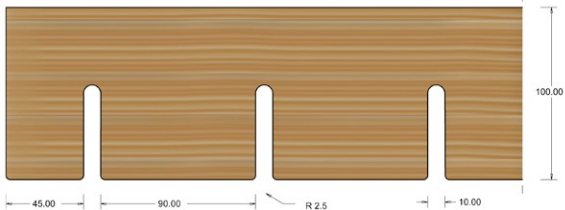

SCALE 1:2

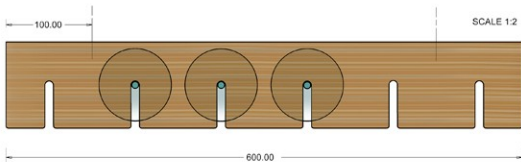
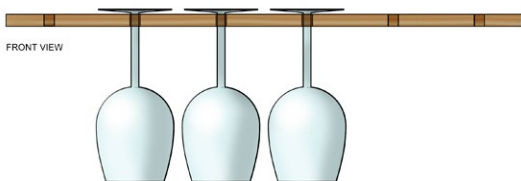

TOP VIEW

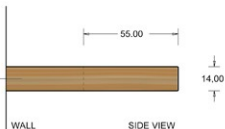

WALL

SIDE VIEW



BACKSIDE
WALL BRACKET 2 pcs

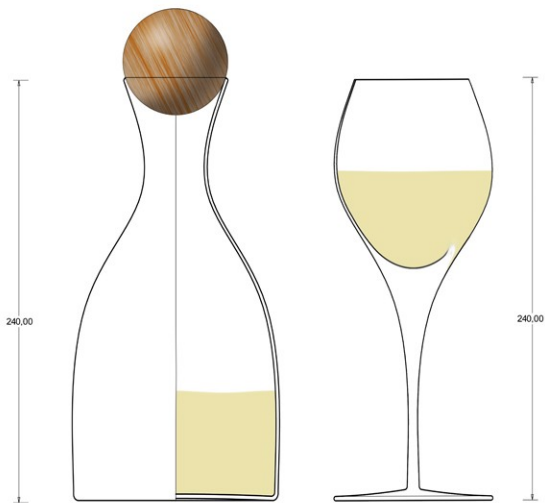

CARAFE WITH WINEGLASS

SET OF THREE PIECES



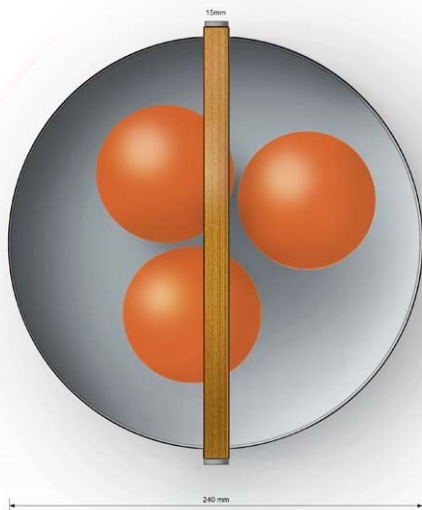
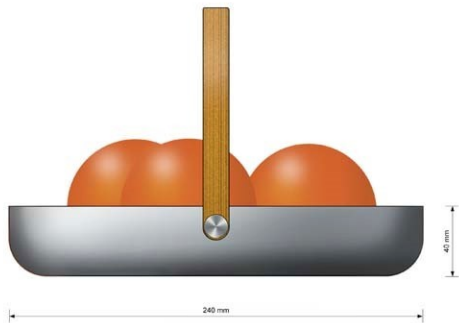

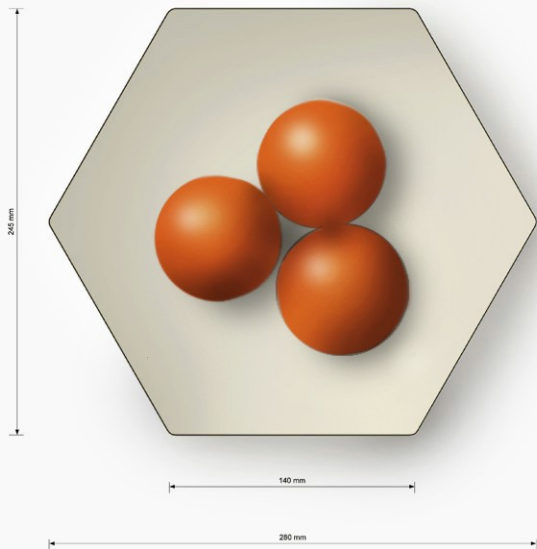
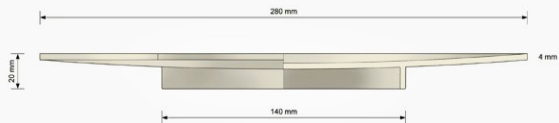

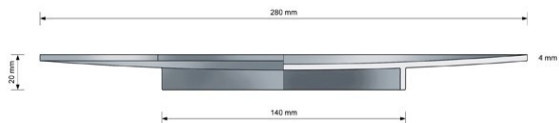

MATERIAL CAST METAL

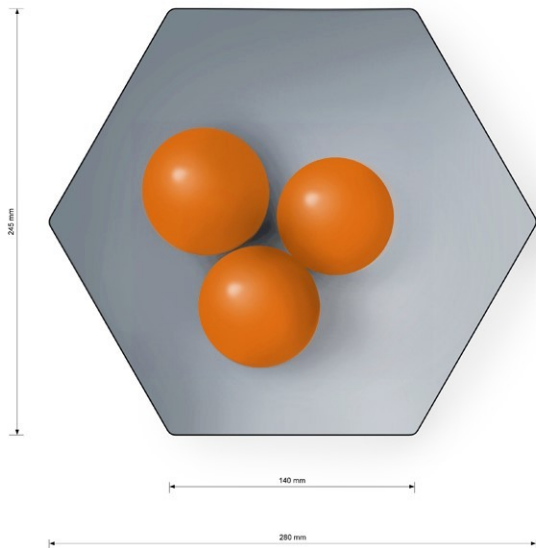

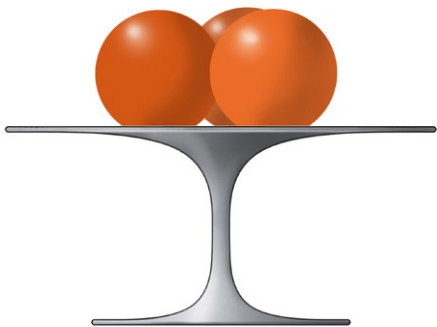

MATERIAL CAST METAL

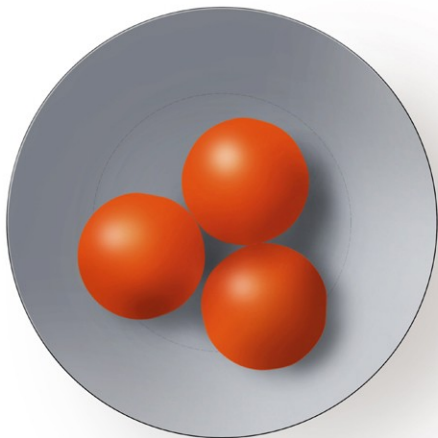

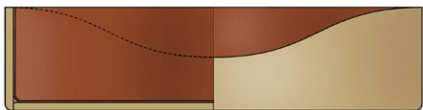

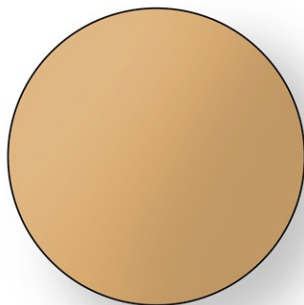

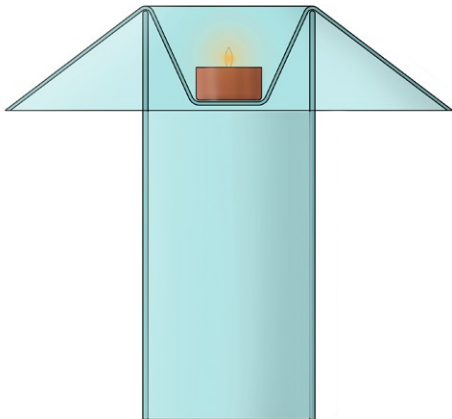



5.00

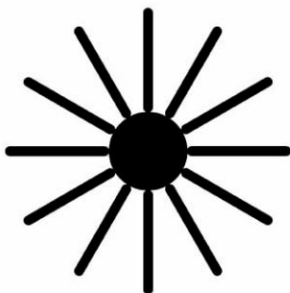

165.00



MATERIAL METAL 2mm

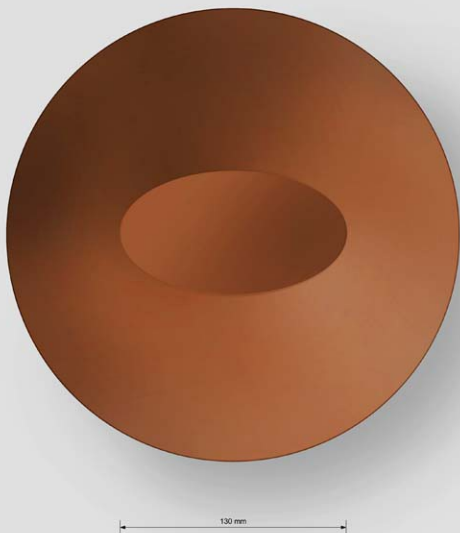

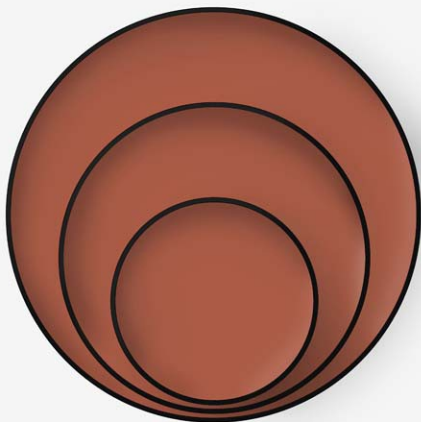

MATERIAL: WOOD / METAL SHEET



400mm



200mm

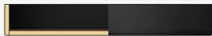

100mm

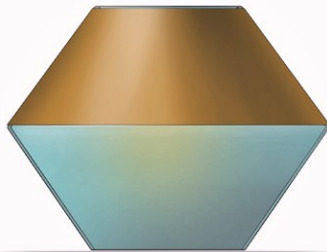
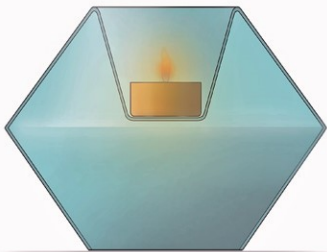

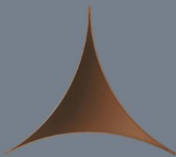

MATERIAL METAL 5mm

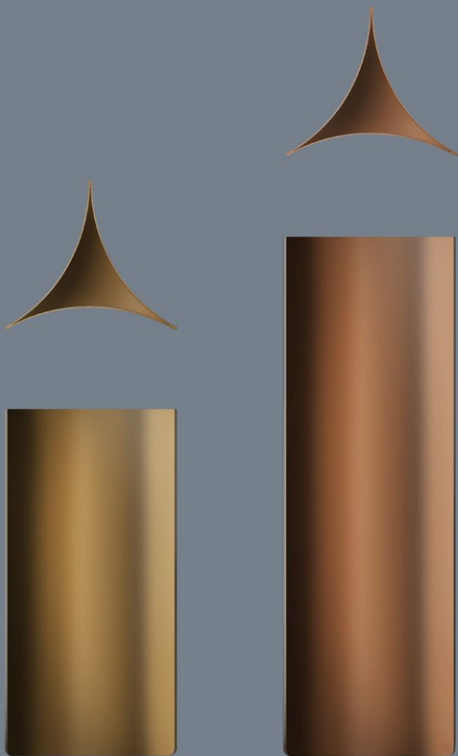

MATERIAL METAL 5mm

BAND VASE

2011-10-17
Design: Magnus Larsson
MAGNUS LARSSON DESIGNS

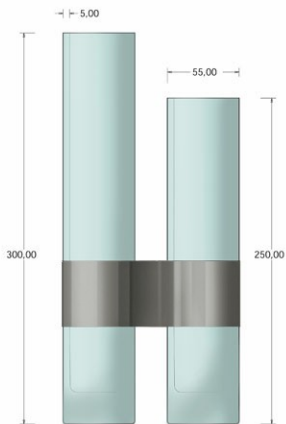

METAL FLEXIBLE BAND



GLASS VASES WITH METAL BAND

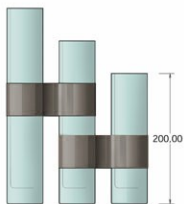

300, 250, 200mm



SCALE 1:2

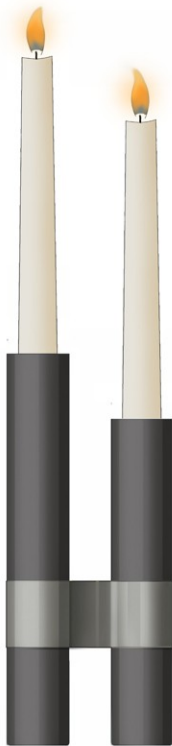

METAL FLEXIBLE BAND



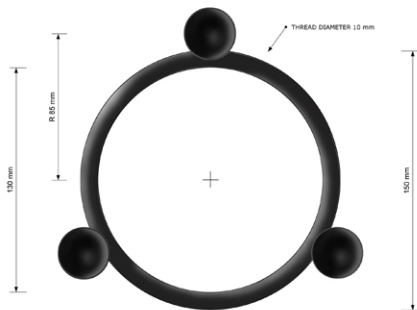
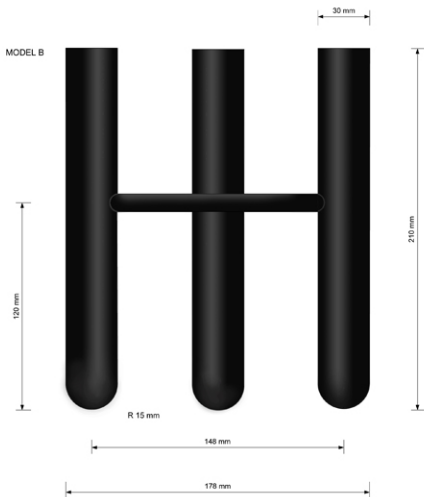

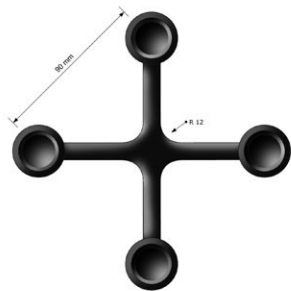
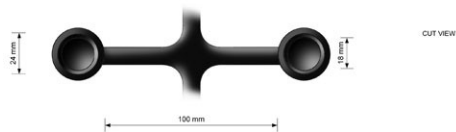
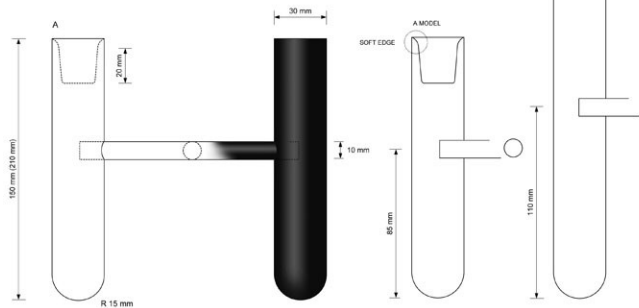



MATERIAL GLASS / METAL



MATERIAL GLASS / METAL



METAL PART

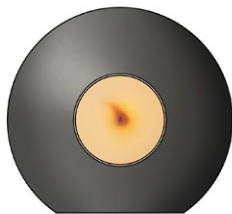

MATERIAL WOOD / BOARD / METAL THREAD

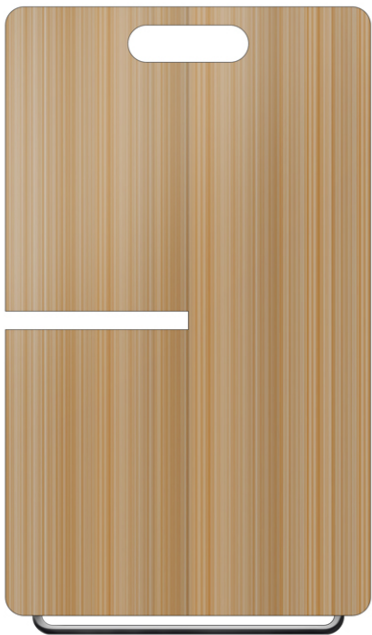

SCALE 1:1



+



SCALE 1:4

300 mm



300 mm



MATERIAL WOOD / BOARD

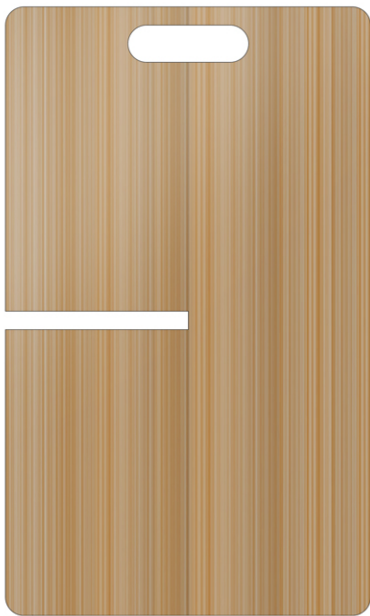

SCALE 1:1



+



SCALE 1:4

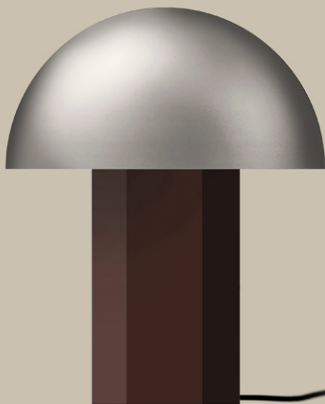

LAMP IN METAL / WOOD

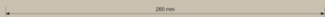

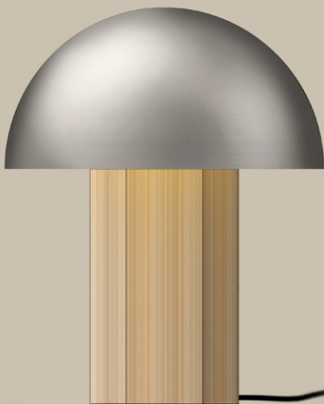

LAMP IN METAL / WOOD

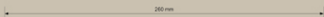

Thank you for looking.

The presentations should be regarded as the beginning of a creative dialogue, between producer and designer.

For more info contact:

info@magnuslofgrendesigns.se