

Welcome to the MLD archive  
for product developers.

© MLD Studio

Click, swipe or scroll to start slideshow.

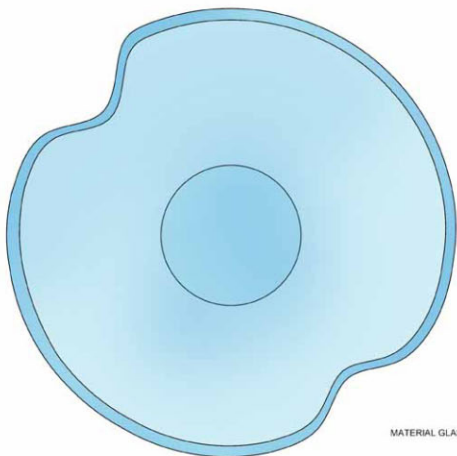

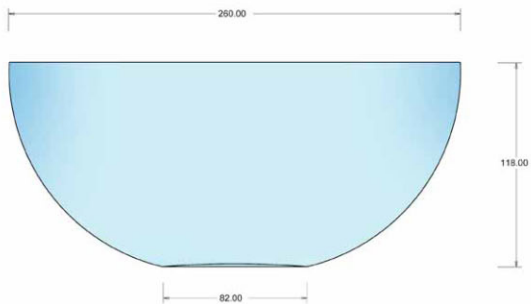
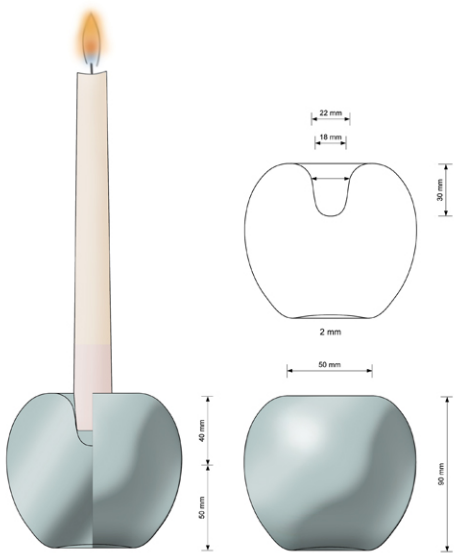

MATERIAL CAST GLASS

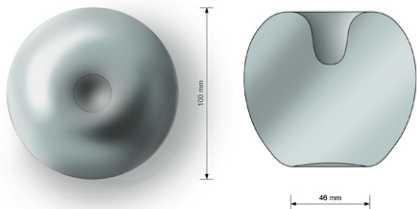

Glass line in blown thin glass, with tray in wood.

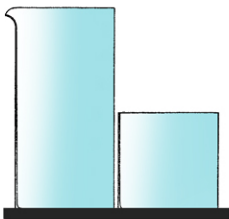
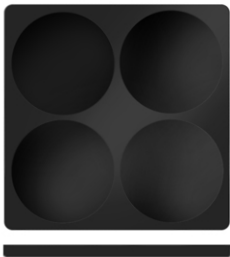
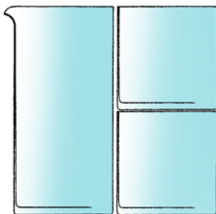
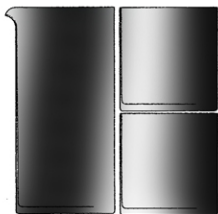
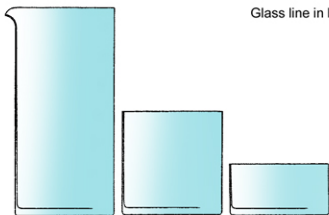

# BOTTLE WITH CORK

2006-11-25

Design: Magnus Lofgren

MAGNUS LOFGREN DESIGNS



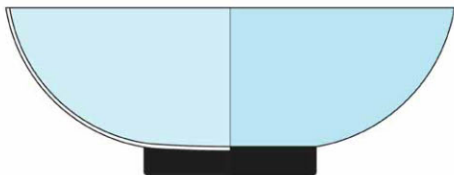

GLASS BOWL 250mm

MATERIAL CAST / BLOWN GLASS

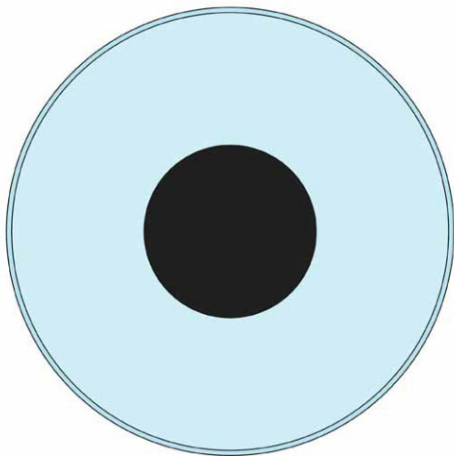

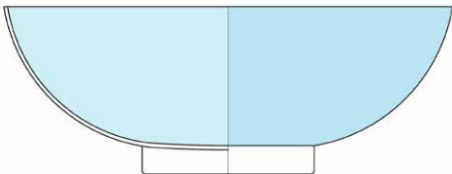

GLASS BOWL 250mm

MATERIAL CAST / BLOWN GLASS

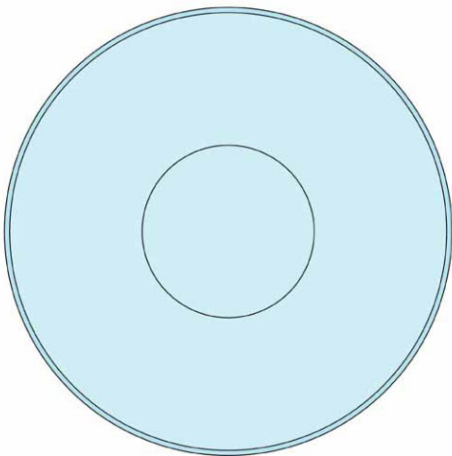



MATERIAL GLASS

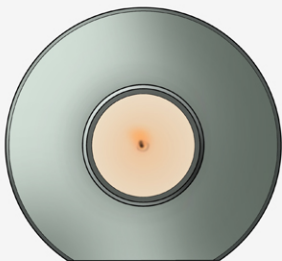



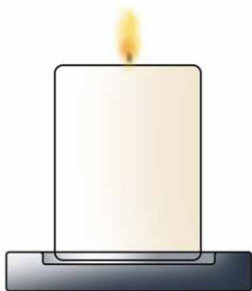

CAST GLASS

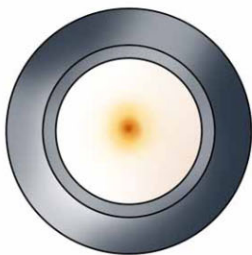

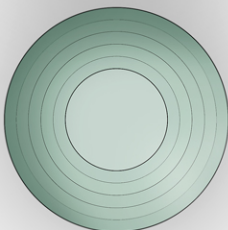
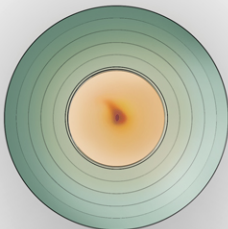

42 mm

92 mm

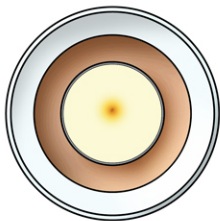
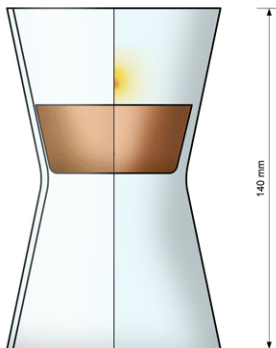

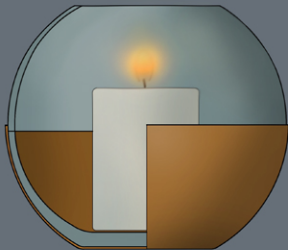

MATERIAL GLASS / METAL

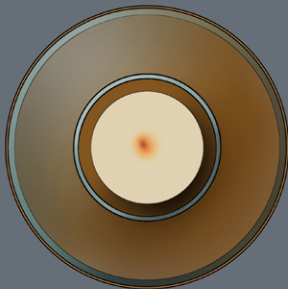

# CARAFE&GLASS

2006-02-23

Design: Magnus Löfgren

MAGNUS LÖFGREN DESIGNS

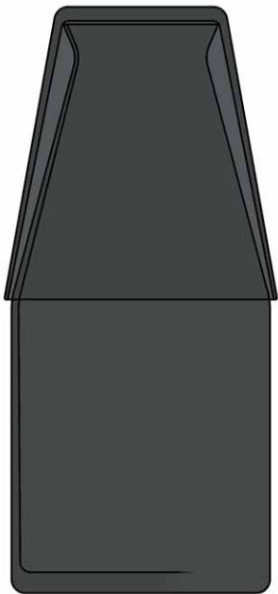

# CARAFE&GLASS

2006-02-23

Design: Magnus Löfgren

MAGNUS LÖFGREN DESIGNS

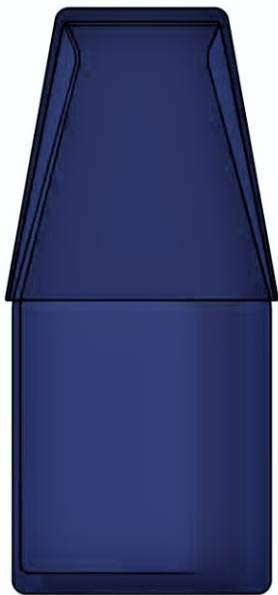

# CARAFE&GLASS

2006-02-23

Design: Magnus Löfgren

MAGNUS LÖFGREN DESIGNS

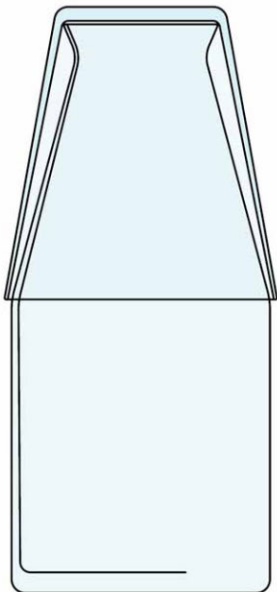

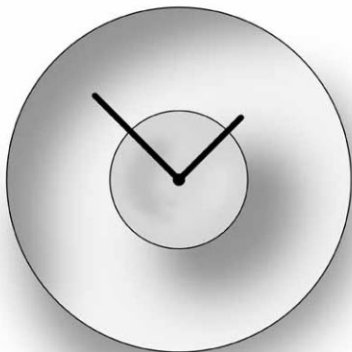

MATERIAL GLASS METAL



RUBBER COVER





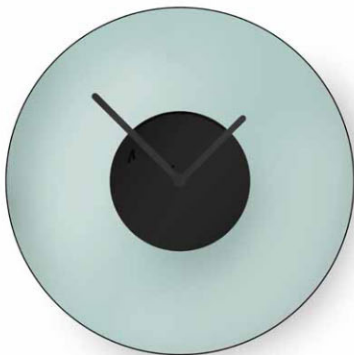

MATERIAL GLASS METAL



RUBBER COVER





MATERIAL GLASS



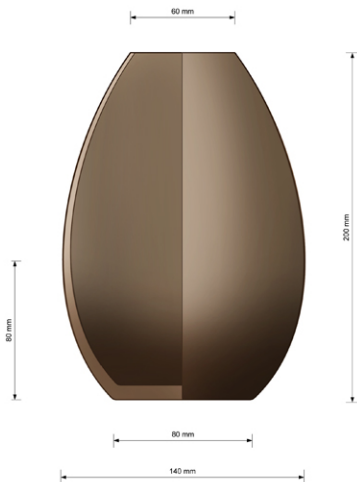

MATERIAL GLASS

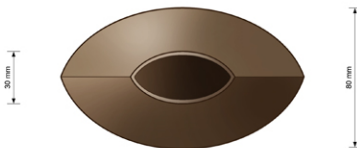

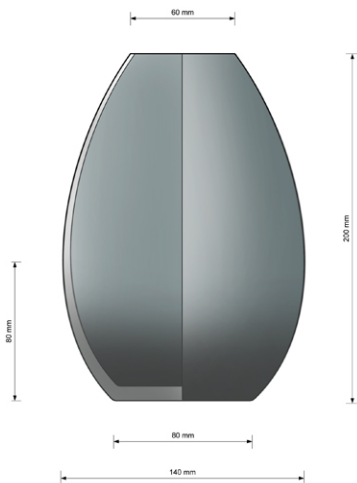

MATERIAL GLASS

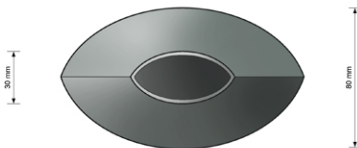

MATERIAL GLASS / METAL

3.00-5.00 GLASS PART



# JUG WITH ICE STOPPER

2003-03-27

Design: Magnus Lofgren

MAGNUS LOFGREN DESIGNS



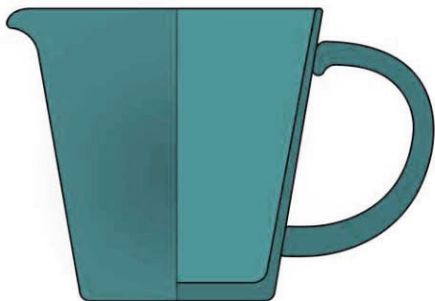

PITCHER IN BLOWN GLASS

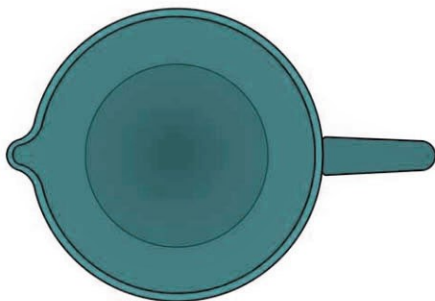

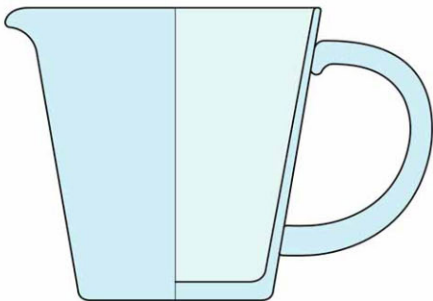

PITCHER IN BLOWN GLASS

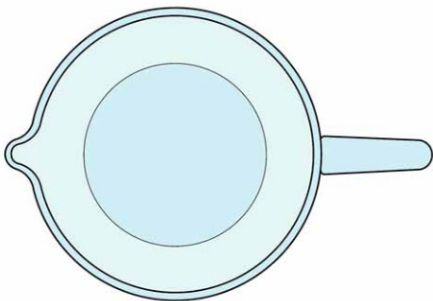



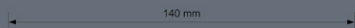
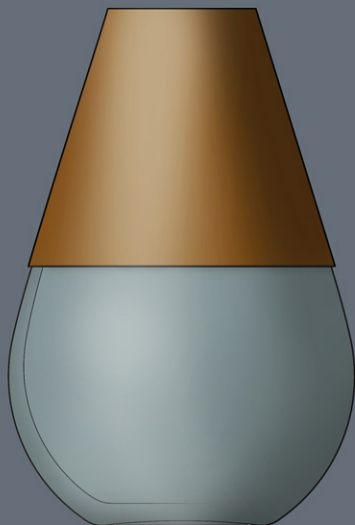

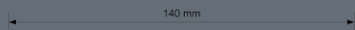
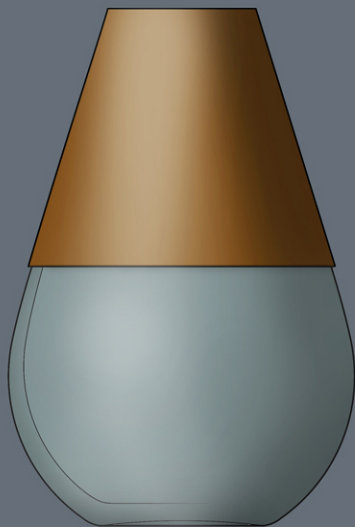

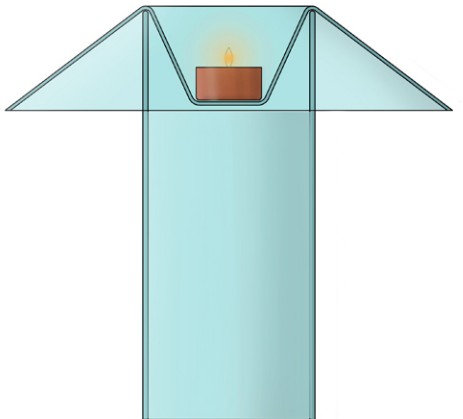

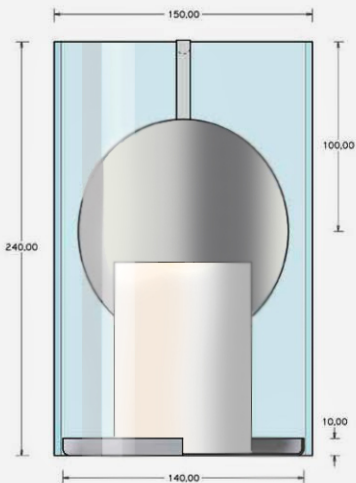

DIAMETER OF MIRROR 130mm

MATERIAL GLASS 4mm / METAL 1mm

8,00

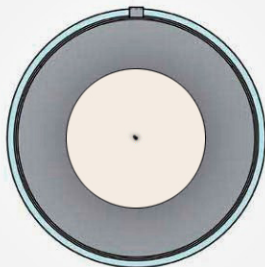

80,00

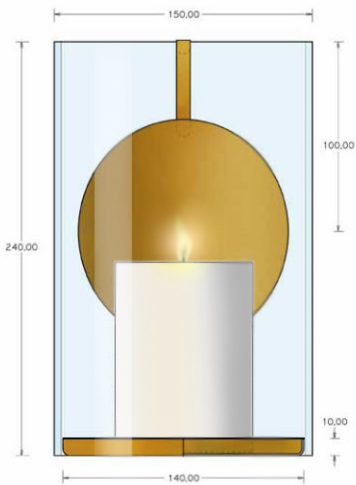

DIAMETER OF MIRROR 130mm

MATERIAL GLASS 4mm / METAL 1mm

8.00

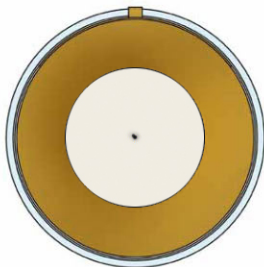

80.00

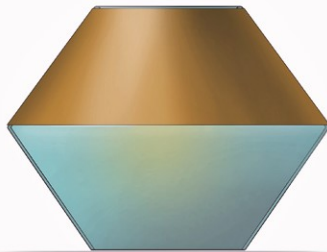
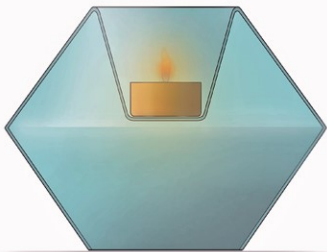

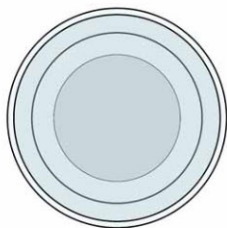
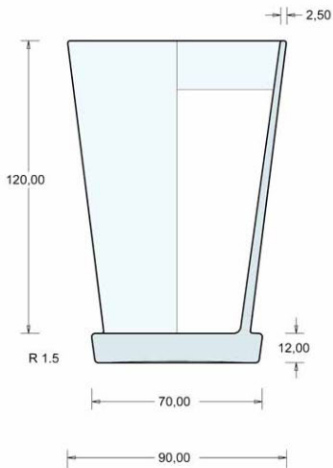

Contains 25cl to line

MATERIAL GLASS

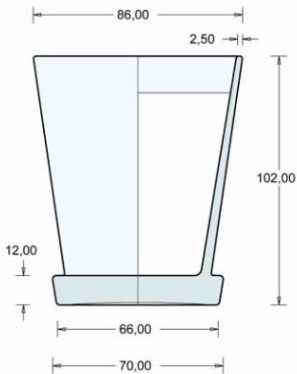

Contains 20cl to line.

MATERIAL GLASS



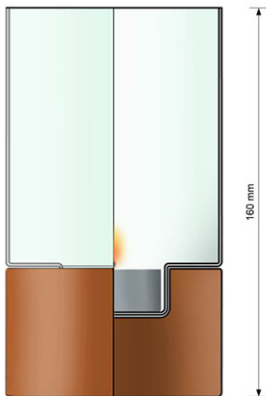

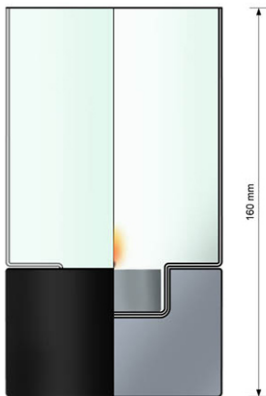

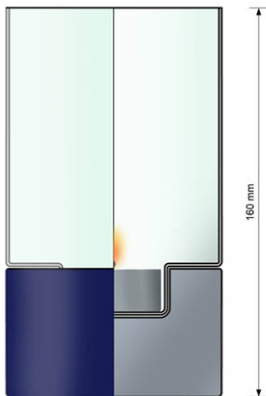

# GLASS VASES WITH METAL LID

2004-01-28

Design: Magnus Lyngbo  
Material: VETRO (GLASS) / ALLUMINIO (ALUMINUM)

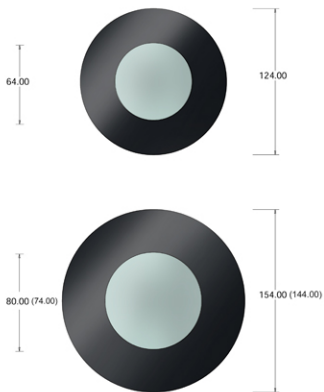
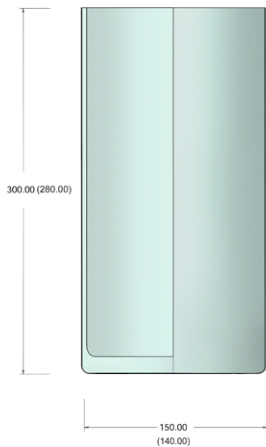
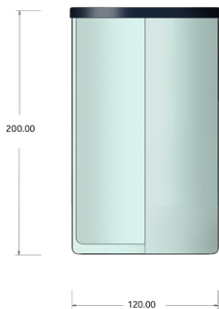

VOTIVE IN CAST GLASS  
FOR TEALIGHT SMALL / LARGE

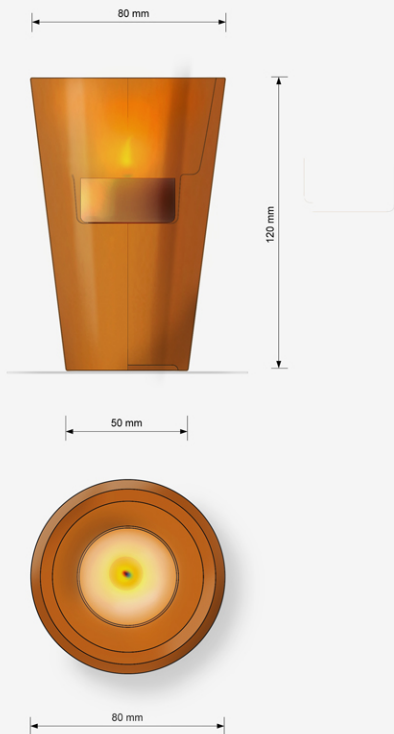

VOTIVE IN CAST GLASS  
FOR TEALIGHT SMALL / LARGE

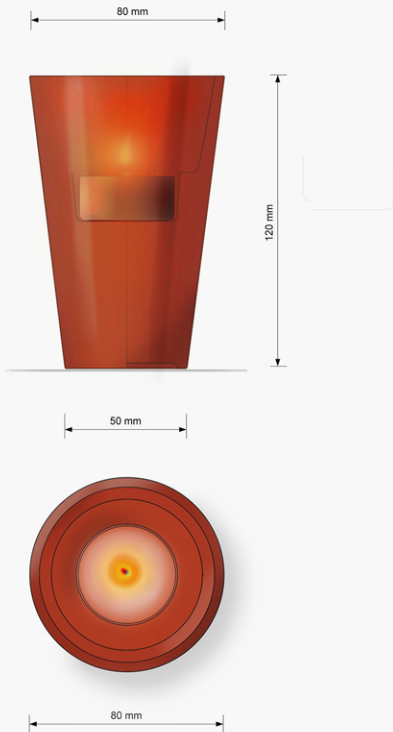

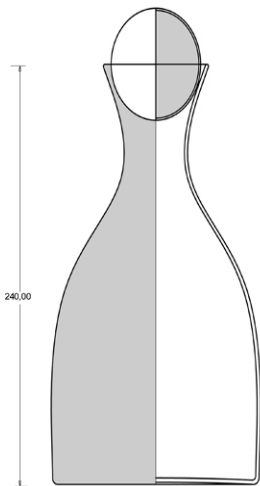

CARAFE WITH WINEGLASS

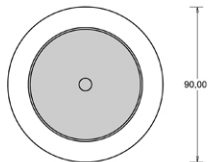
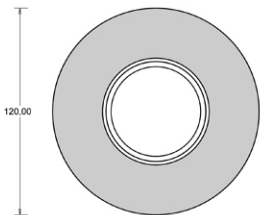
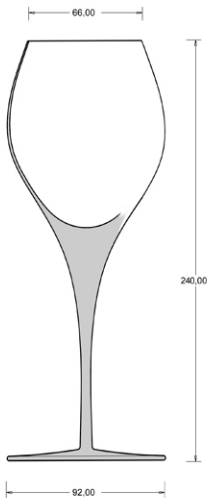

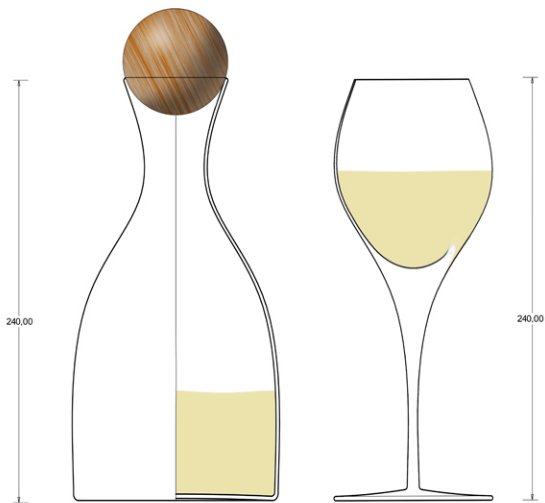

CARAFE WITH WINEGLASS

SET OF THREE PIECES







NECKLACE  
2011-05-04  
MAGNUS LOFGREN DESIGNS  
Design: Magnus Löfgren  
Copyright

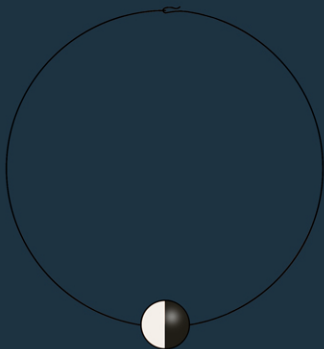

MATERIAL GLASS

NECKLACE  
2011-05-04  
MAGNUS LOFGREN DESIGNS  
Design: Magnus Lofgren  
Copyright

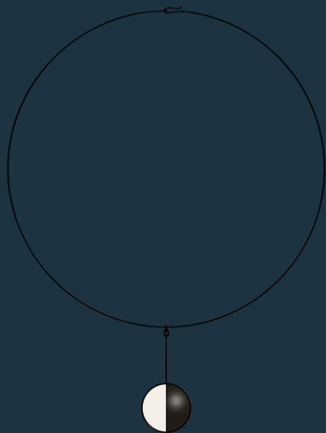

MATERIAL GLASS

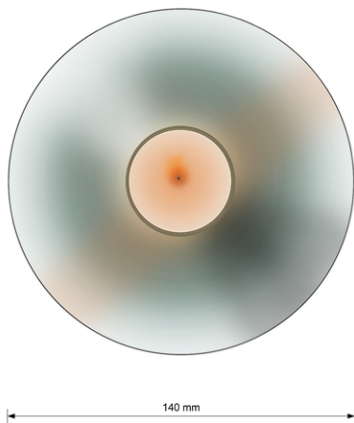
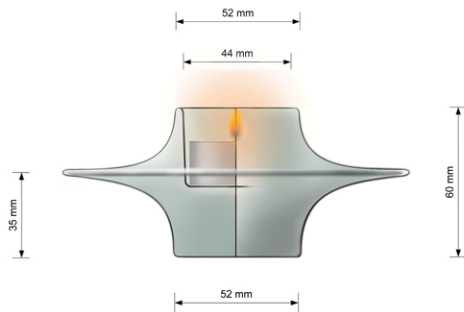

VOTIVE FOR TEALIGHT 38mm

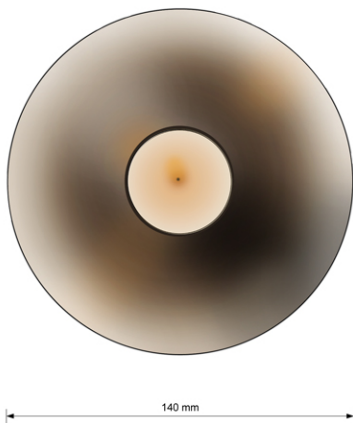
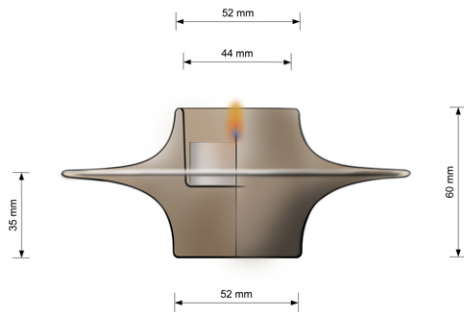

VOTIVE FOR TEALIGHT 38mm

Thank you for looking.

The presentations should be regarded as the beginning of a creative dialogue, between producer and designer.

For more info contact:

[info@magnuslofgrendesigns.se](mailto:info@magnuslofgrendesigns.se)