

Welcome to the MLD archive
for product developers.

© MLD Studio

Click, swipe or scroll to start slideshow.

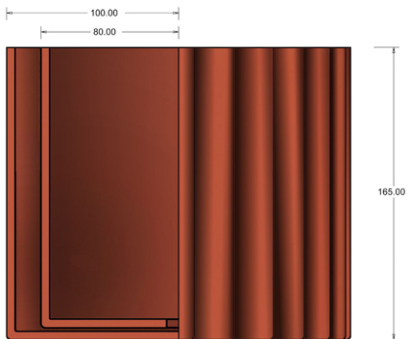

FLOWERPOT IN CERAMIC

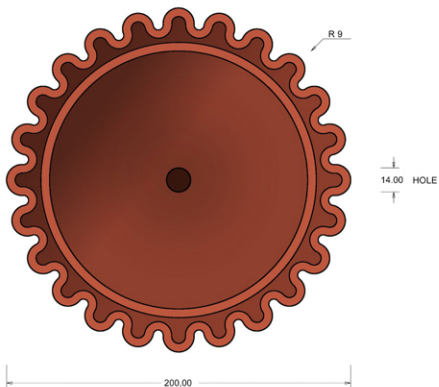

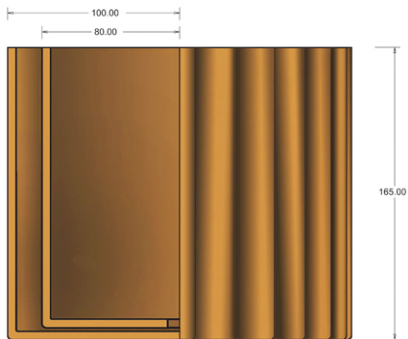

FLOWERPOT IN CERAMIC

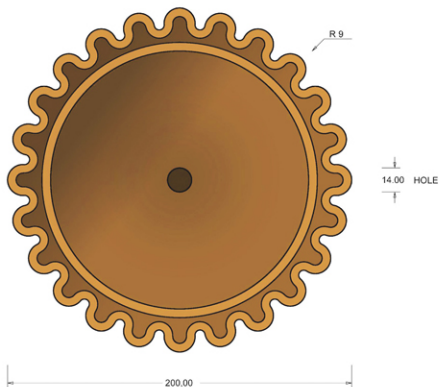

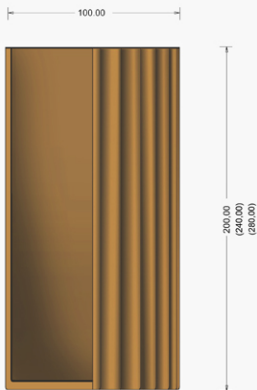

VASE IN CERAMIC



ROUND MODEL



OVAL MODEL (same heights)

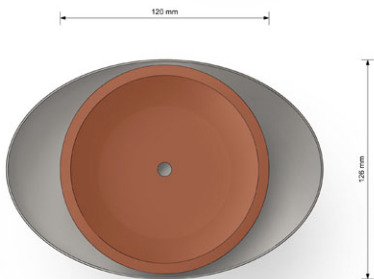
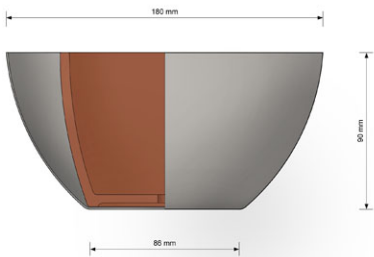

HOLE 8 mm

MATERIAL METAL 1mm / CERAMIC 6mm

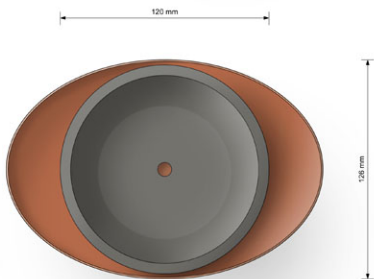
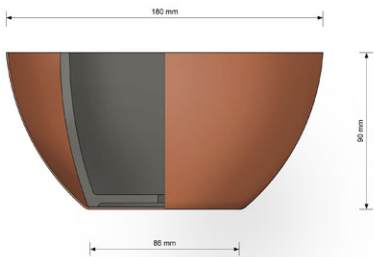

HOLE 8 mm

MATERIAL METAL 1mm / CERAMIC 6mm

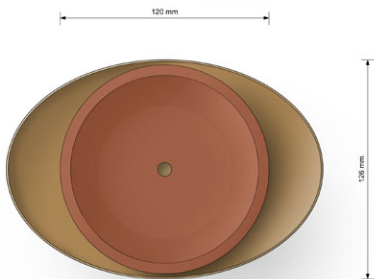
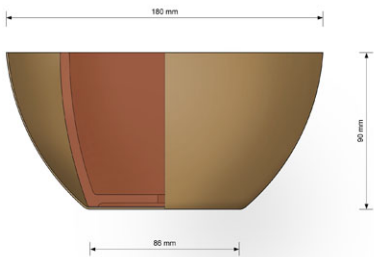

HOLE 8 mm

MATERIAL METAL 1mm / CERAMIC 6mm



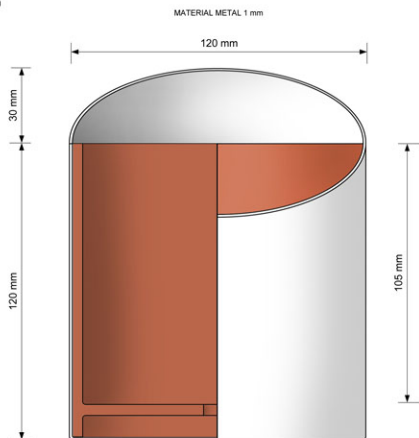

INNER POT IN CERAMIC MATERIAL

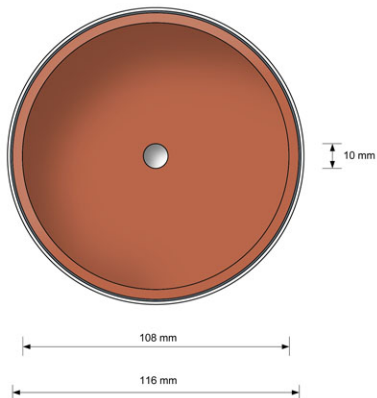

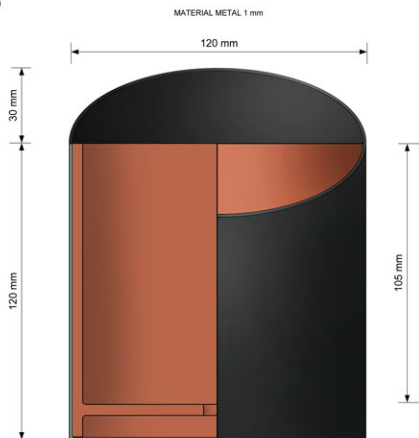

INNER POT IN CERAMIC MATERIAL

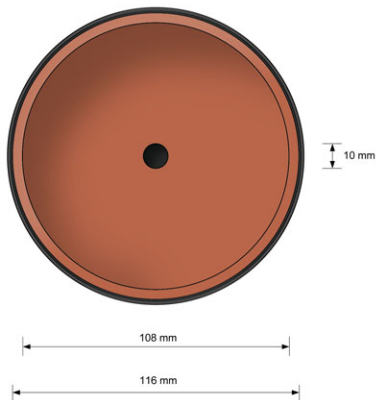

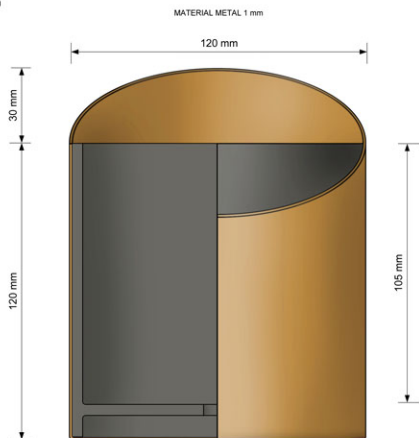

INNER POT IN CERAMIC MATERIAL

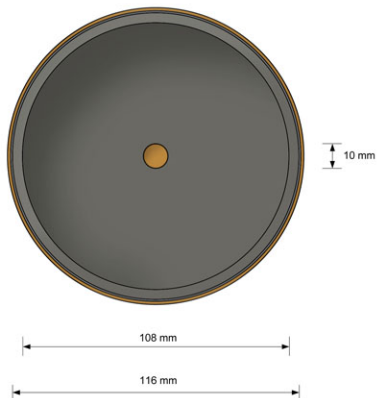

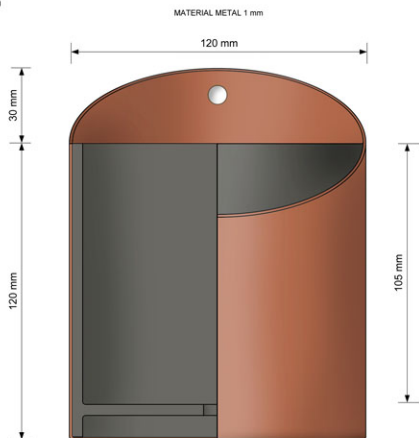

INNER POT IN CERAMIC MATERIAL

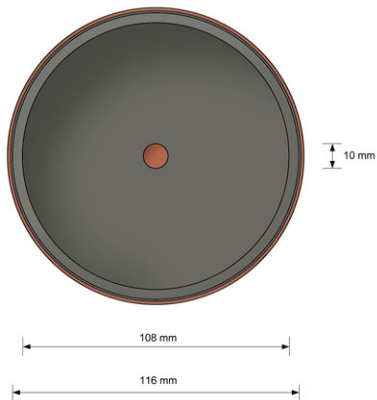

MATERIAL METAL 1 mm

120 mm



INNER POT IN CERAMIC MATERIAL

MATERIAL METAL 1 mm

120 mm

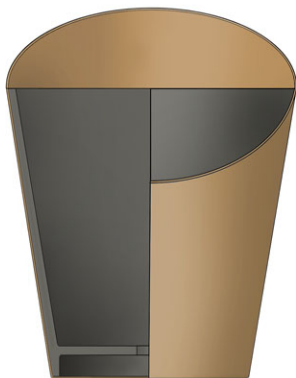

INNER POT IN CERAMIC MATERIAL

MATERIAL METAL 1 mm

120 mm

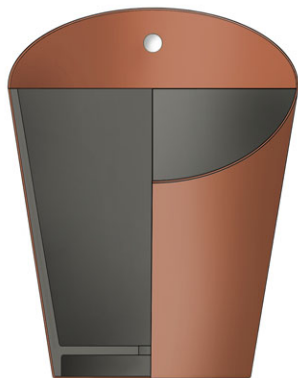

INNER POT IN CERAMIC MATERIAL

MATERIAL METAL 1 mm

120 mm

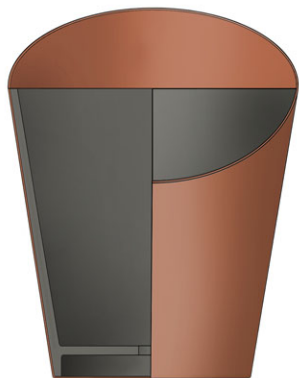

INNER POT IN CERAMIC MATERIAL

MATERIAL CAST METAL

RIM 3 mm



RIM 3.5 mm



MATERIAL CAST METAL

RIM 3 mm



RIM 3.5 mm



MATERIAL CAST METAL

RIM 3-4 mm



120 mm

75 mm



MATERIAL CAST METAL

RIM 3 mm

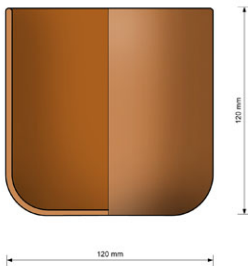

RIM 3.5 mm



MATERIAL CAST METAL

RIM 3 mm

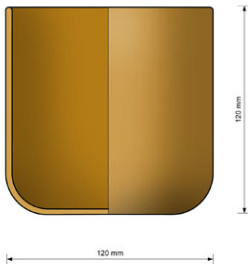

RIM 3.5 mm



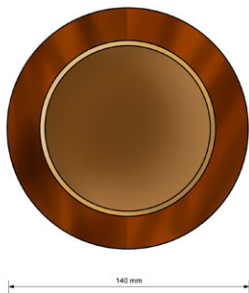
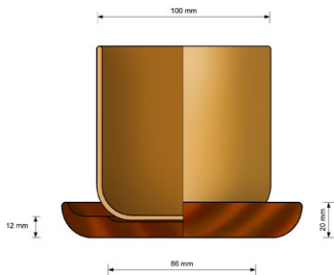

MATERIAL CAST METAL / WOOD

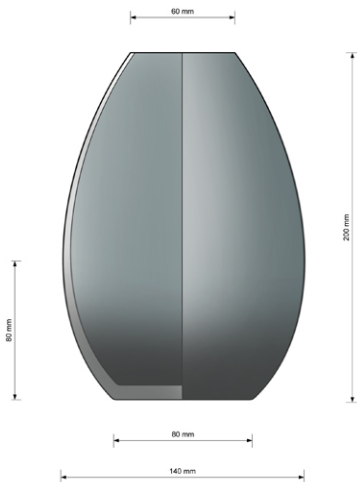

MATERIAL GLASS

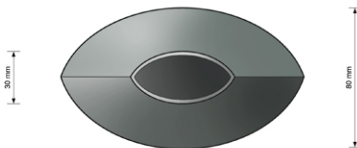

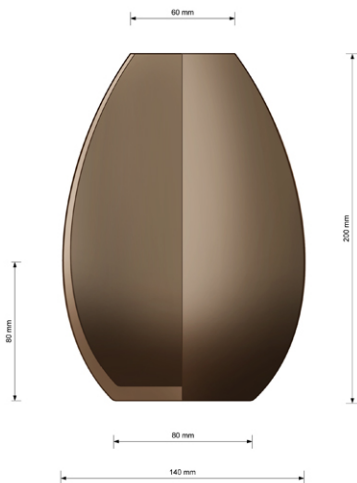

MATERIAL GLASS

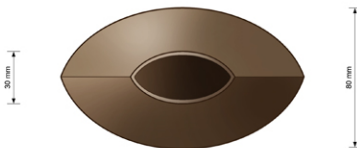

GLASS VASES WITH METAL LID

2004 02 08

Design: Magnus Lyngbo
Material: LIP GLASS 90 3/3260

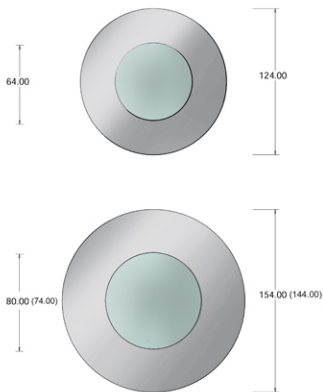
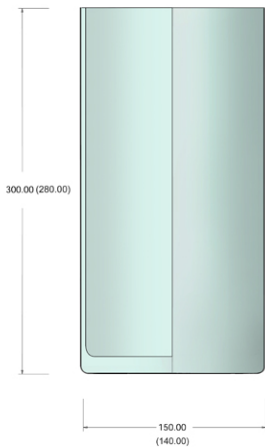
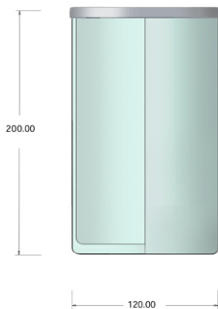

GLASS VASES WITH METAL LID

2004-01-28
Design: Magnus Lyngbo
Material: VIKO glass, BK 33380

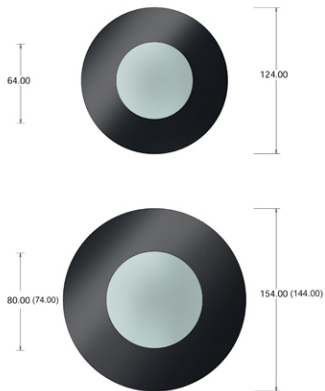
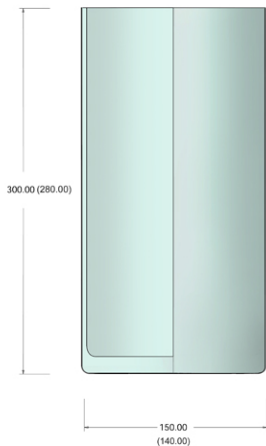
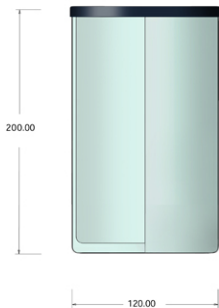

MATERIAL METAL 1.5 mm

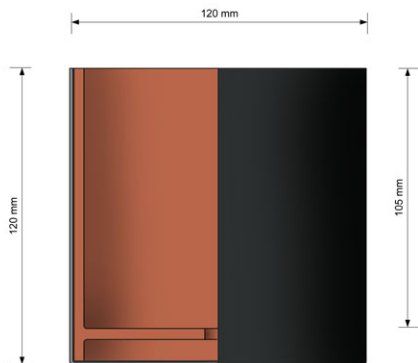

INNER POT IN CERAMIC MATERIAL

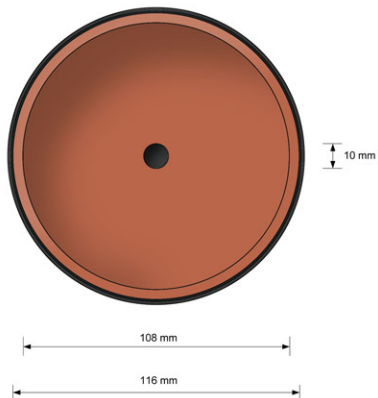

MATERIAL METAL 1.5 mm

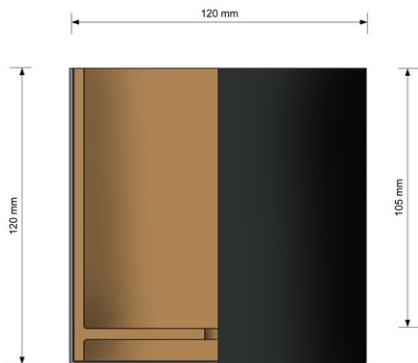

INNER POT IN CERAMIC MATERIAL

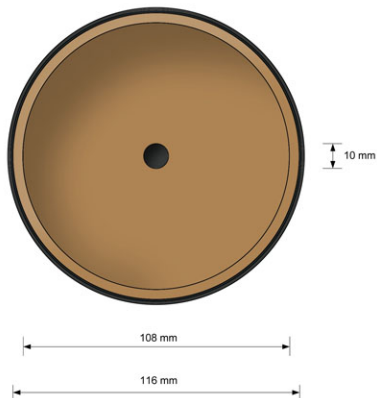

MATERIAL METAL 1.5 mm

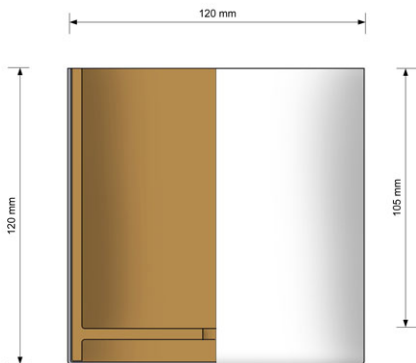

INNER POT IN CERAMIC MATERIAL

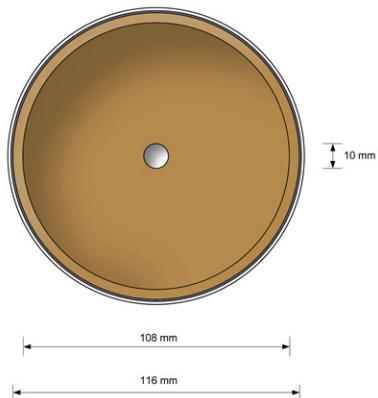

VASE METAL
2016-02-01 (2011-01-12)
MAGNUS LÖFGREN DESIGNS
Design: Magnus Löfgren
Copyright



MATERIAL METAL / WOOD



VASE METAL
2016-02-01 (2011-01-12)
MAGNUS LÖFGREN DESIGNS
Design: Magnus Löfgren
Copyright



MATERIAL METAL / WOOD

MATERIAL METAL 1 mm

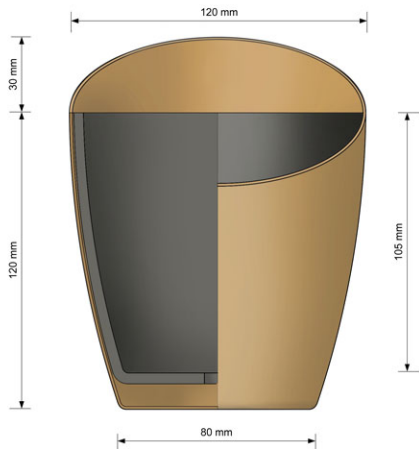

INNER POT IN CERAMIC MATERIAL

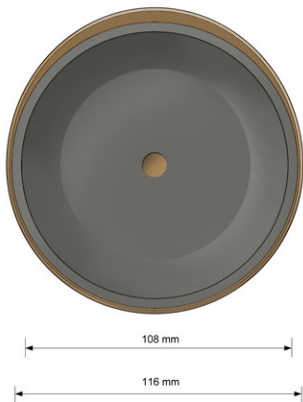

MATERIAL METAL 1 mm

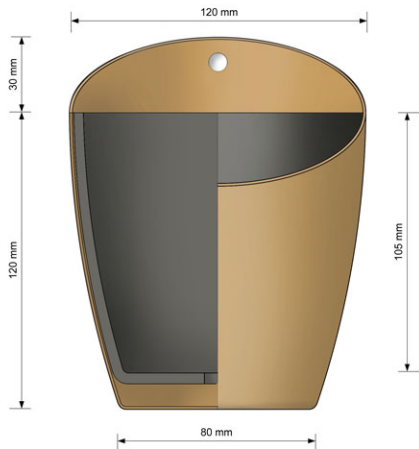

INNER POT IN CERAMIC MATERIAL

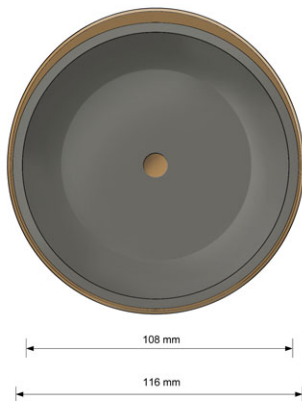

MATERIAL METAL 1.5 mm

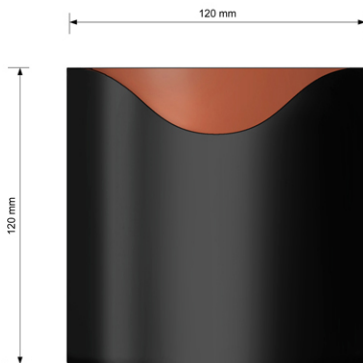

INNER POT IN CERAMIC MATERIAL

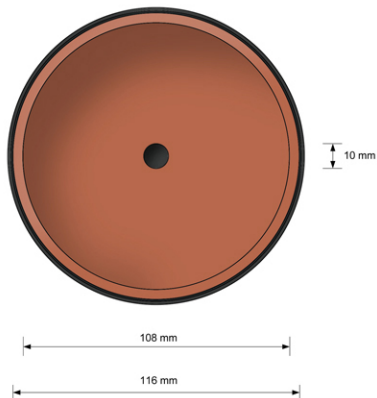

MATERIAL METAL 1.5 mm

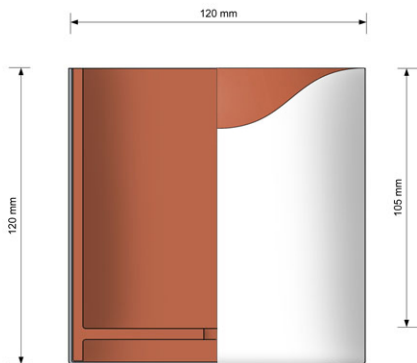

INNER POT IN CERAMIC MATERIAL

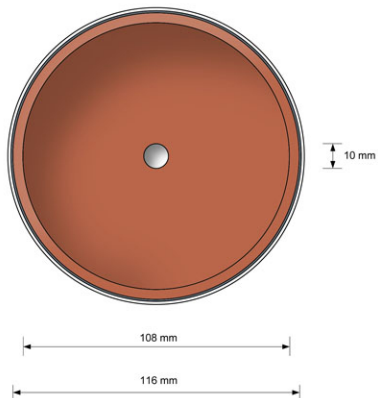

MATERIAL METAL 1.5 mm

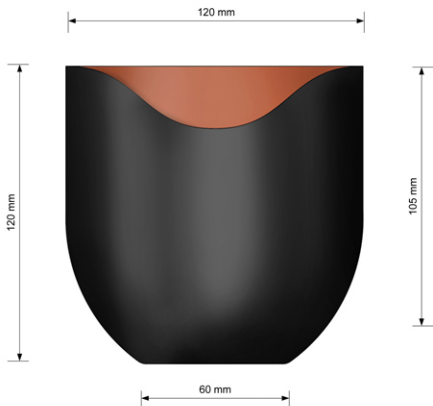

INNER POT IN CERAMIC MATERIAL

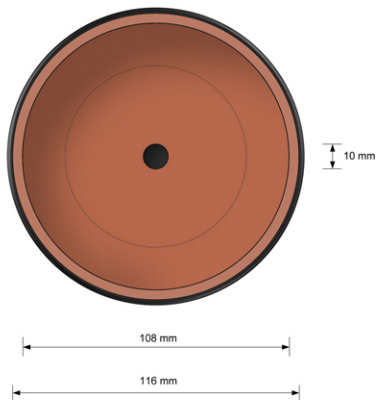

BAND VASE

2005-10-17
Design: Magnus Larsson
MAGNUS LARSSON DESIGNS

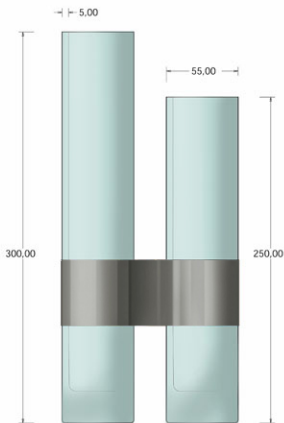

METAL FLEXIBLE BAND



GLASS VASES WITH METAL BAND

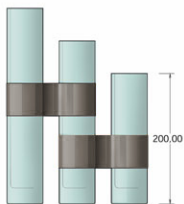
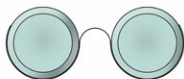

300, 250, 200mm



SCALE 1:2

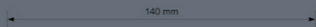
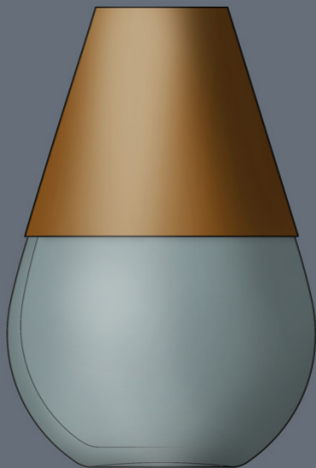

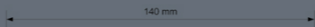
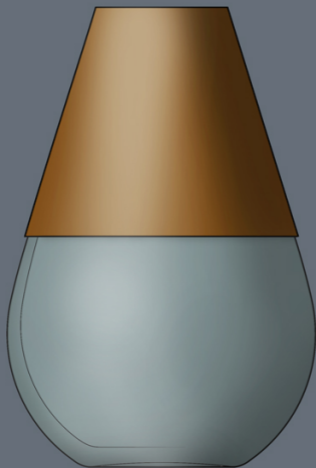

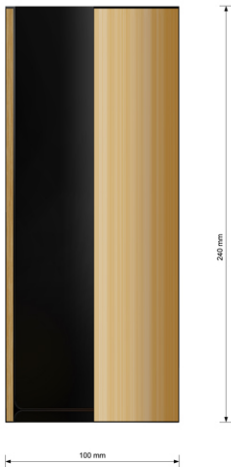

FLOWERPOT

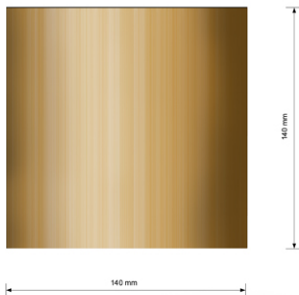

FLOWERPOT

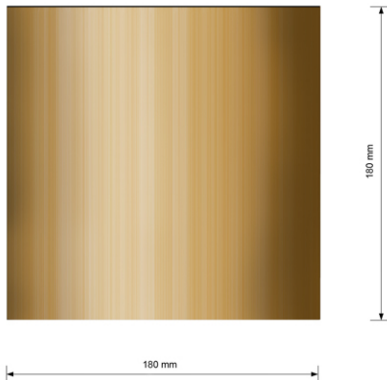
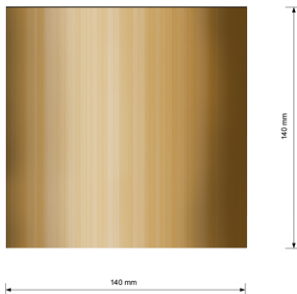

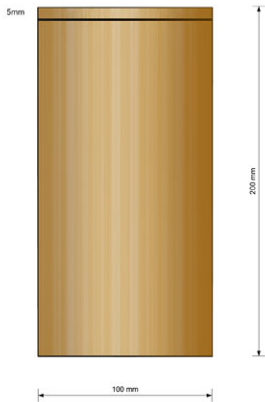



80 mm



80 mm

MATERIAL 1mm

120 mm



120 mm

MATERIAL 1.5mm

80 mm



60 mm

MATERIAL 1mm

120 mm



120 mm

MATERIAL 1.5mm

80 mm

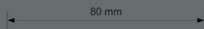

MATERIAL 1mm

120 mm

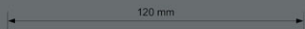

MATERIAL 1.5mm



MATERIAL 1.25mm

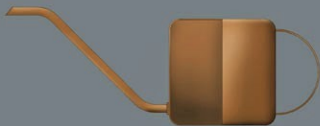
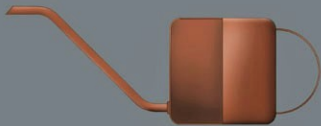
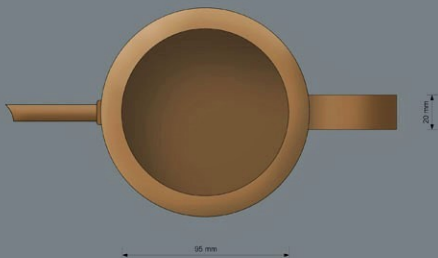
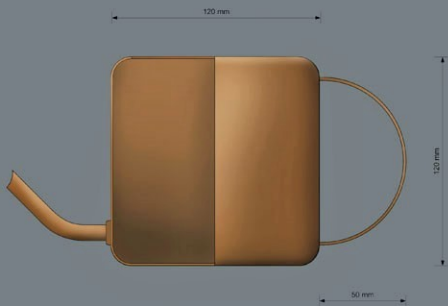

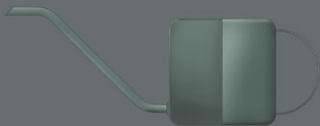
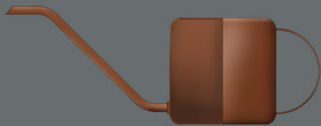
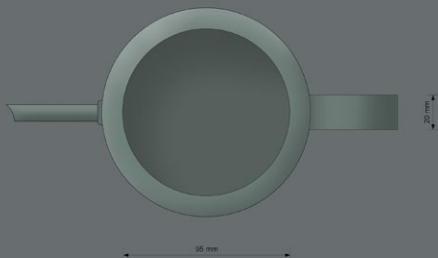
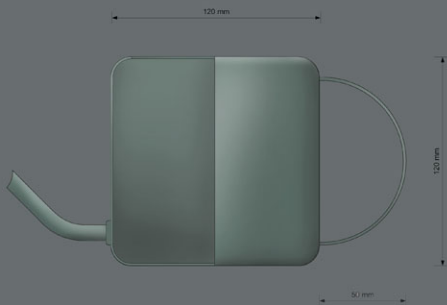

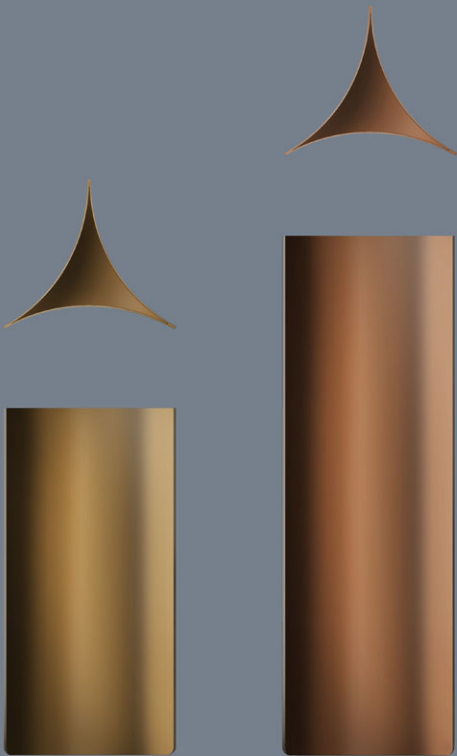

MATERIAL METAL 5mm

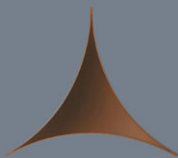

MATERIAL METAL 5mm

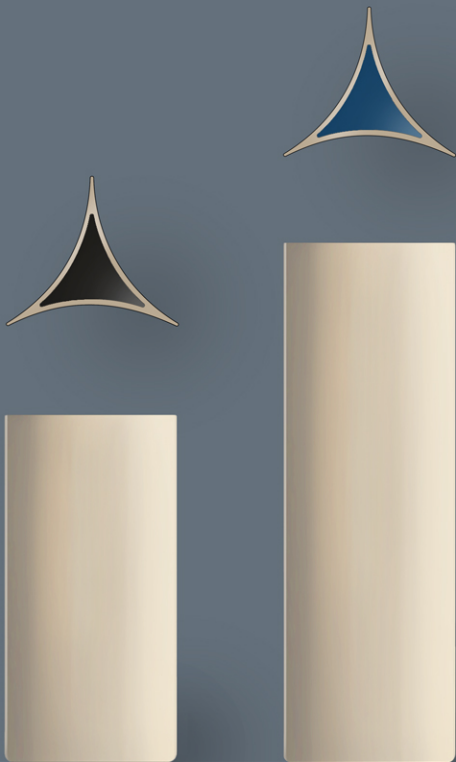

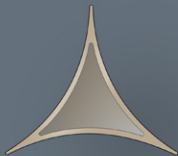

MATERIAL CERAMIC

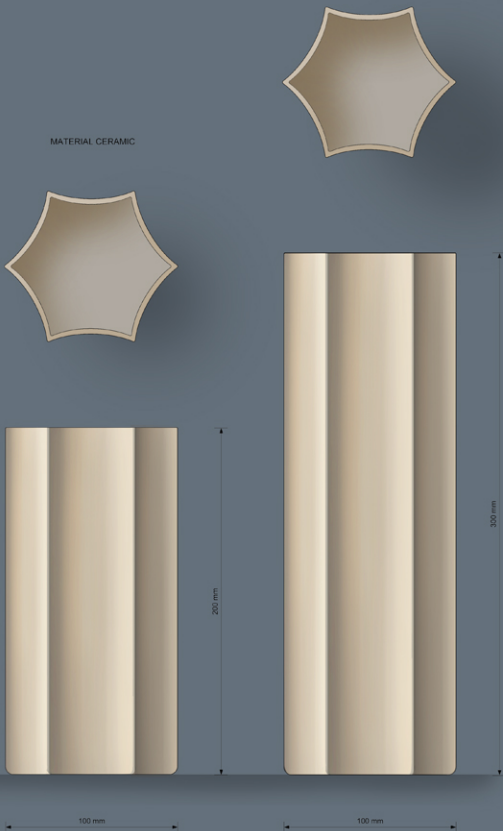

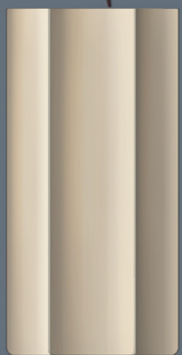

200 mm

100 mm

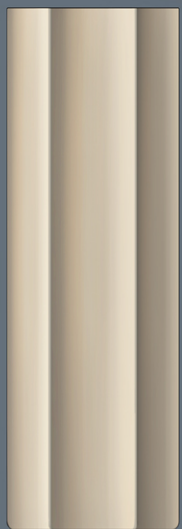

300 mm

100 mm

Thank you for looking.

The presentations should be regarded as the beginning of a creative dialogue, between producer and designer.

For more info contact:

info@magnuslofgrendesigns.se