

Welcome to the MLD archive
for product developers.

© MLD Studio

Click, swipe or scroll to start slideshow.

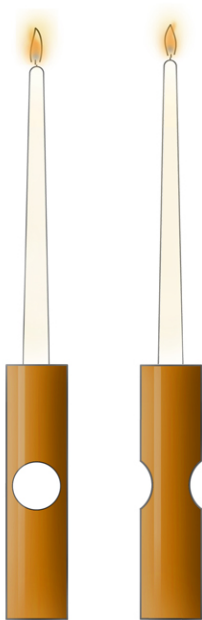

MATERIAL METAL

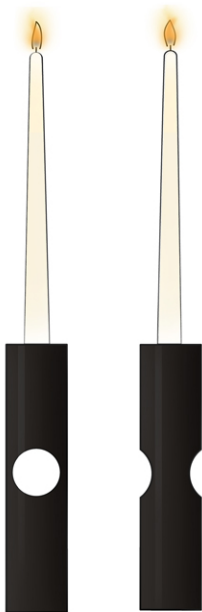

MATERIAL METAL

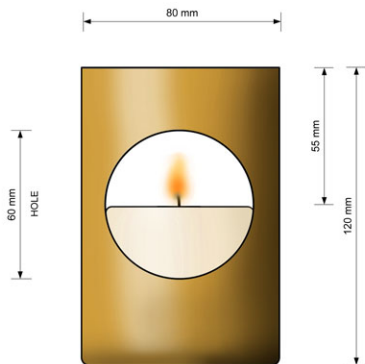

MATERIAL METAL 1mm

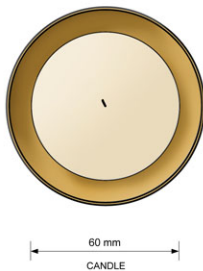

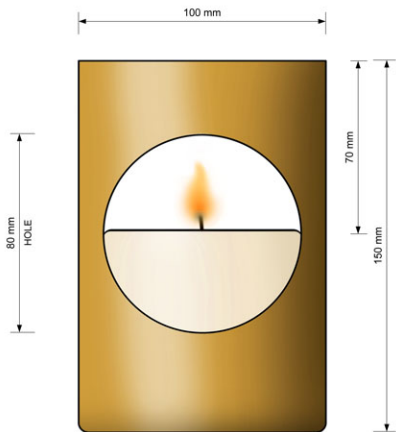

MATERIAL METAL 1mm

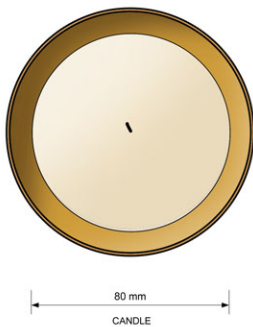

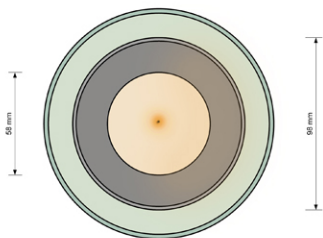
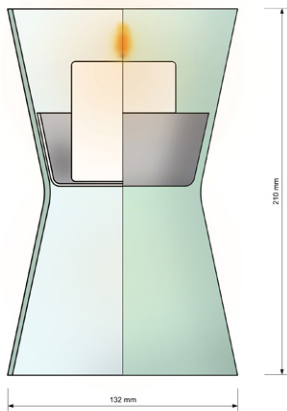

LARGE MODEL (Pillar candle 60mm) (Large tealight 58mm)

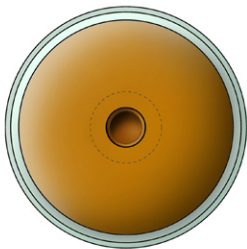
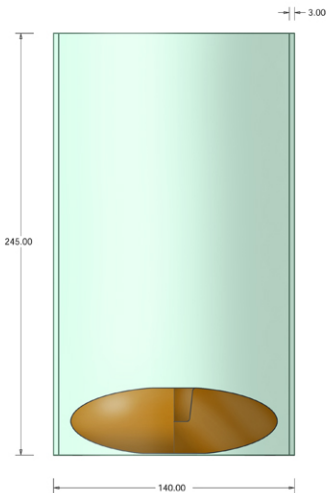

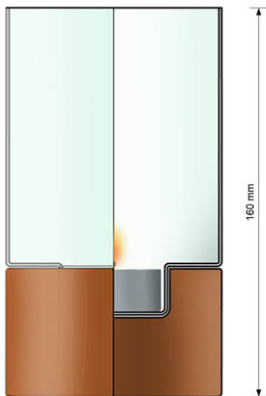

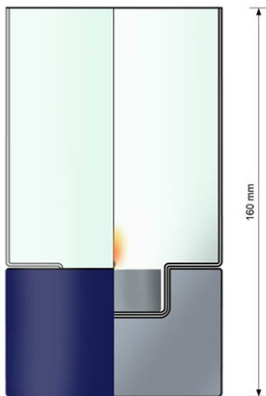

MINI HURRICANE
2012-03-14
MAGNUS LÖFGREN DESIGNS
Design: Magnus Löfgren
Copyright

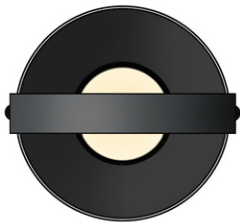
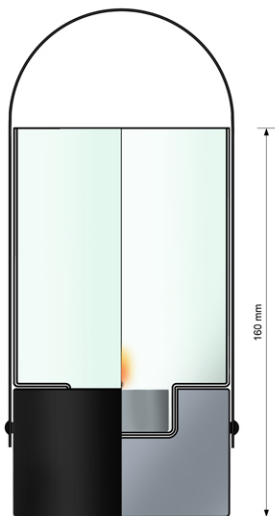

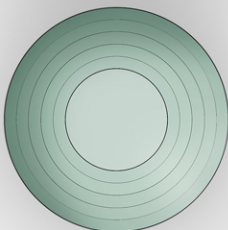
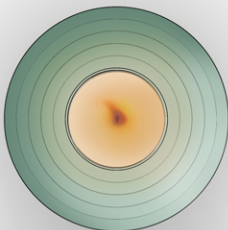

42 mm

92 mm



CANDLEHOLDER METAL
2013-02-20
MAGNUS LÖFGREN DESIGNS
Design: Magnus Löfgren
Copyright





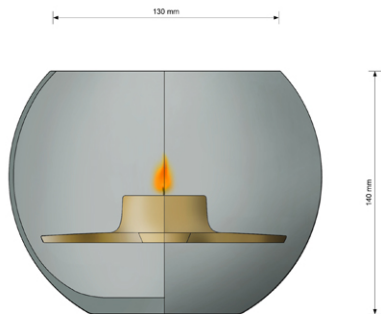

MATERIAL GLASS / METAL

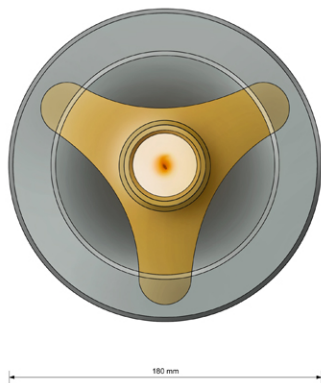

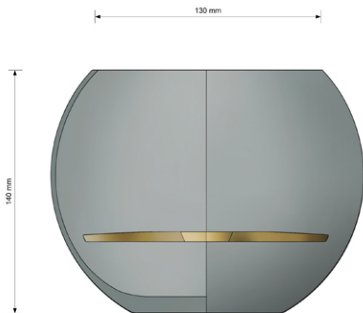

MATERIAL GLASS / METAL



METAL/GLASS WINDLIGHT

2002-11-27

Design: Magnus Lofgren

MAGNUS LOFGREN DESIGNS

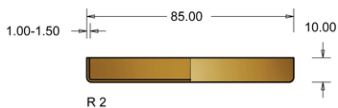
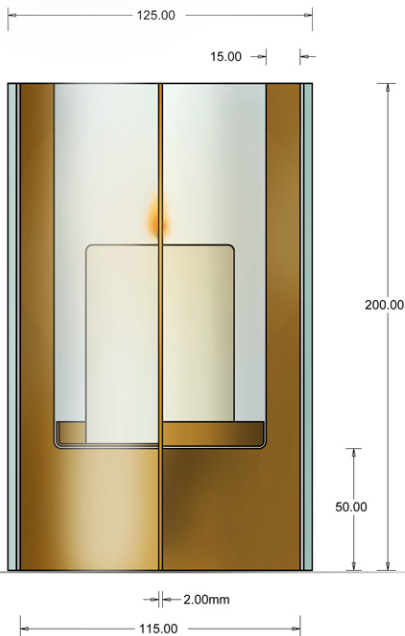

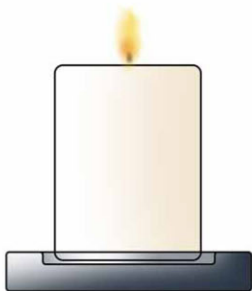

CAST GLASS

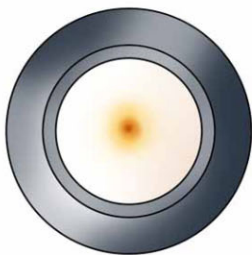



MATERIAL GLASS

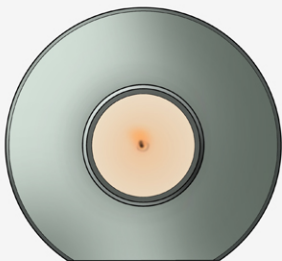

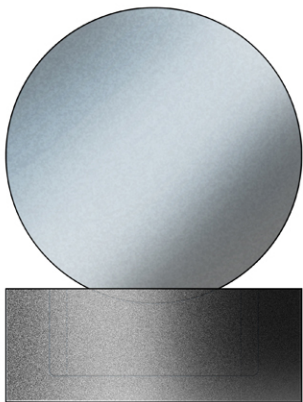

MATERIAL CONCRETE / METAL



CANDLEHOLDER
2012-02-14
MAGNUS LOFGREN DESIGNS
Design: Magnus Löfgren
Copyright



MATERIAL WOOD

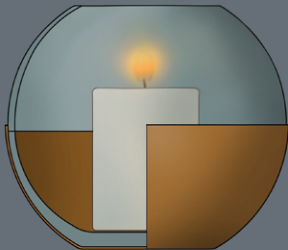

MATERIAL GLASS / METAL

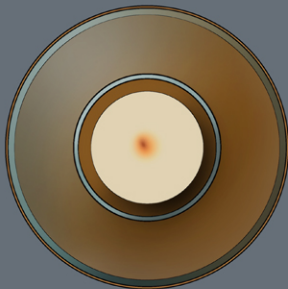

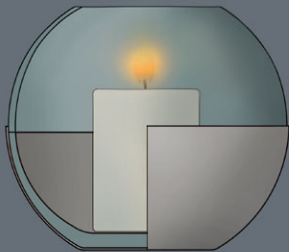

MATERIAL GLASS / METAL

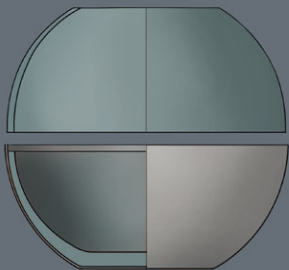



MATERIAL GLASS / METAL

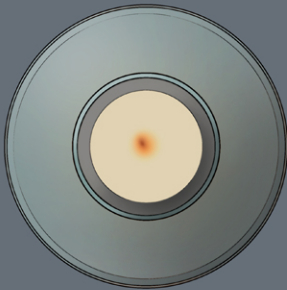

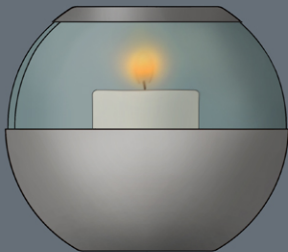

MATERIAL GLASS / METAL

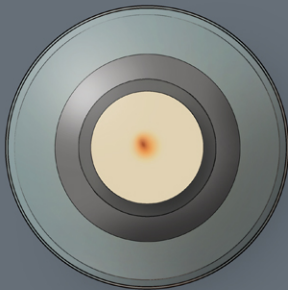

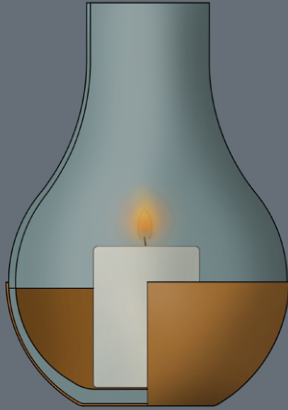

MATERIAL GLASS / METAL

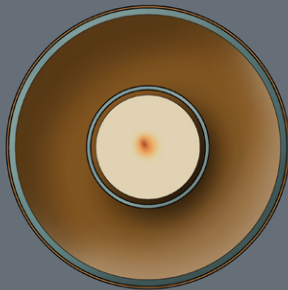



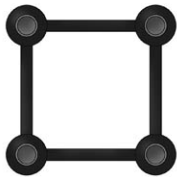
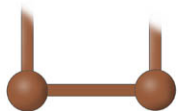
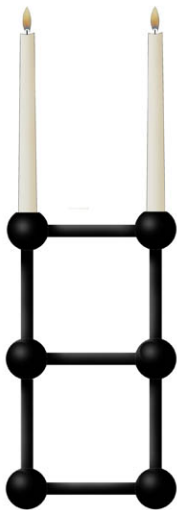

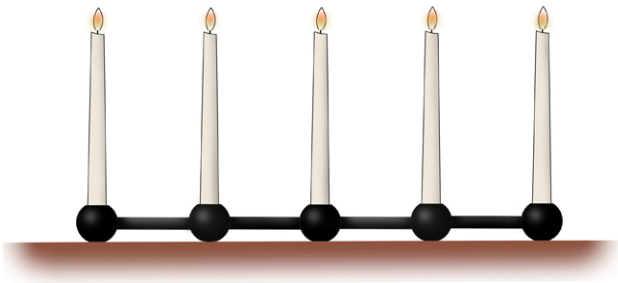

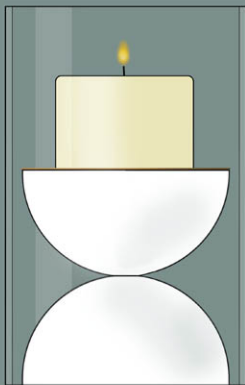

MATERIAL METAL 1mm / GLASS 4mm

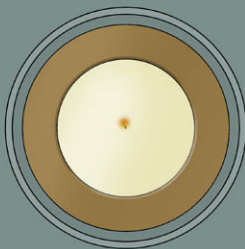

CANDLEHOLDER

2004-10168
Design: Magnus Löfgren
MAGNUS LOFGREN DESIGNS

MATERIAL METAL



100,00

26,00

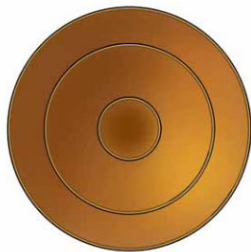

70,00

CANDLEHOLDER

2004-1016

Design: Magnus Löfgren

MAGNUS LOFGREN DESIGNS

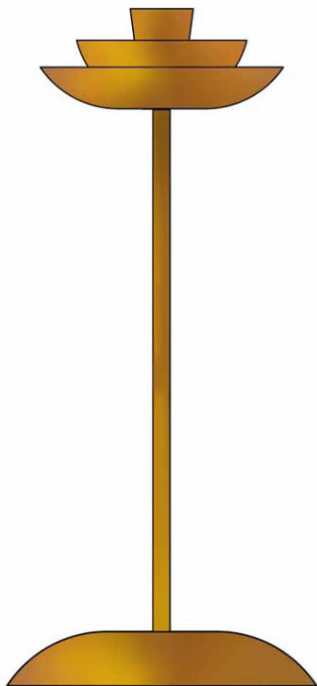

MATERIAL METAL

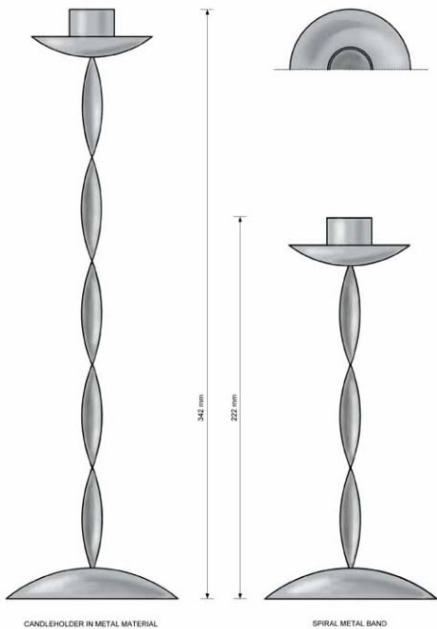

CANDLEHOLDER IN METAL MATERIAL

SPIRAL METAL BAND



MATERIAL GLASS



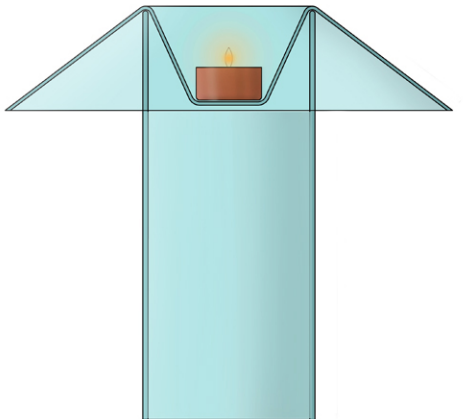

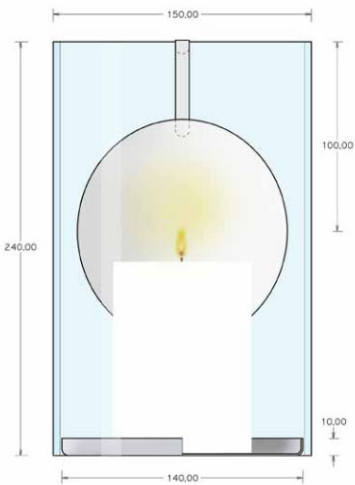

DIAMETER OF MIRROR 130mm

MATERIAL GLASS 4mm / METAL 1mm

8,00

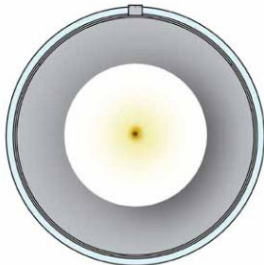

80,00

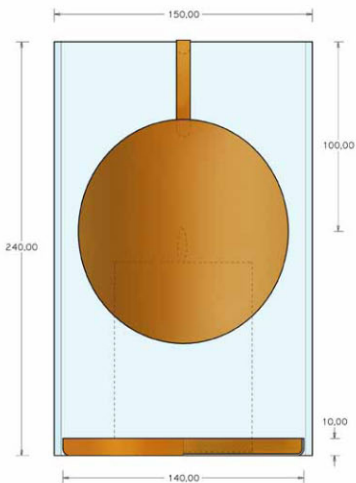

DIAMETER OF MIRROR 130mm

MATERIAL GLASS 4mm / METAL 1mm

8,00

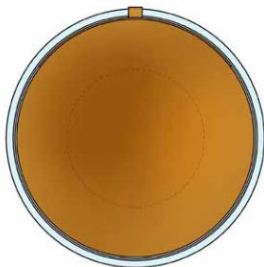

80,00

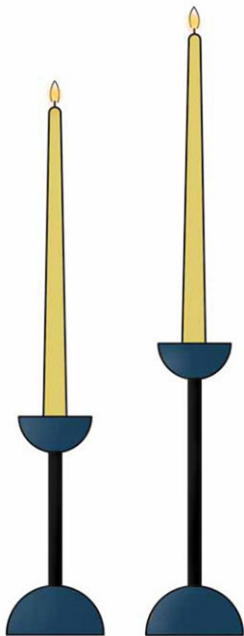

MATERIAL WOOD / METAL

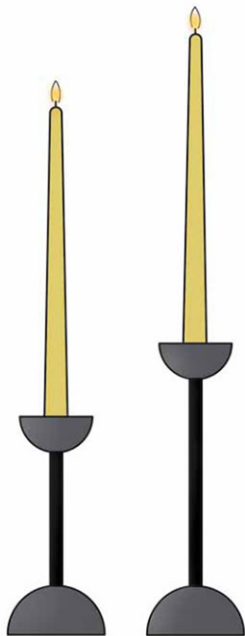

MATERIAL WOOD / METAL

CANDLEHOLDER WOOD / METAL
2011-04-25
MAGNUS LÖFGREN DESIGNS
Design: Magnus Löfgren
Copyright



MATERIAL WOOD / METAL

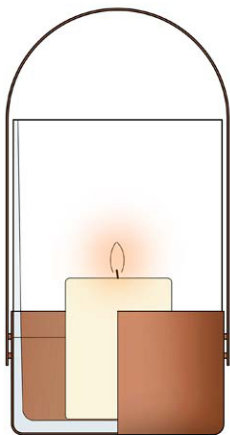

MATERIAL GLASS / METAL

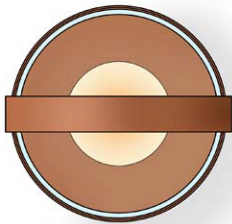

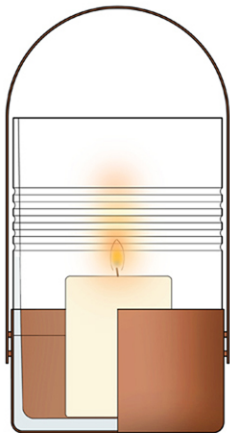

MATERIAL GLASS / METAL

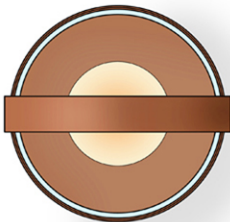

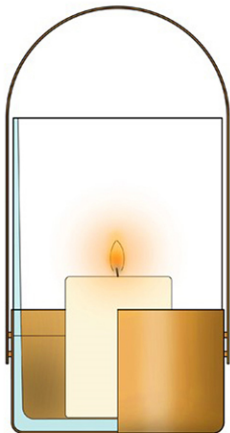

MATERIAL GLASS / METAL

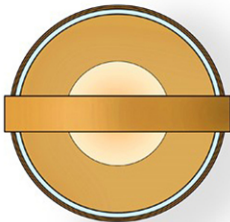



MATERIAL METAL

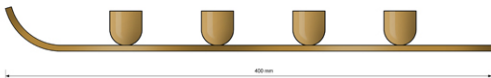

MATERIAL CAST METAL

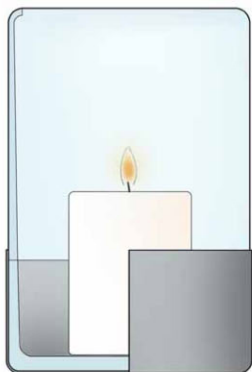

MATERIAL GLASS / METAL

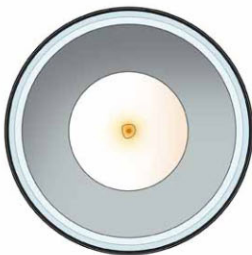



MATERIAL GLASS / METAL

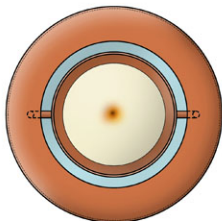

124 mm

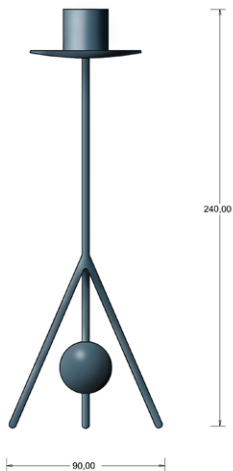

MATERIAL METAL

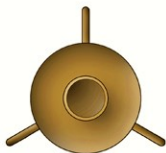
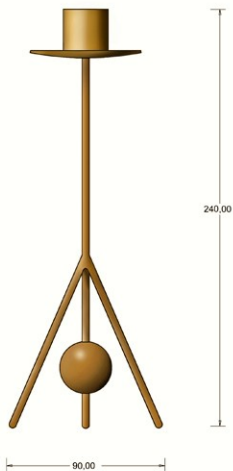

MATERIAL METAL



MATERIAL METAL

CANDLE TUBE MEDIUM

2003-06-11
Design Magnus Lofgren
MAGNUS LOFGREN DESIGNS

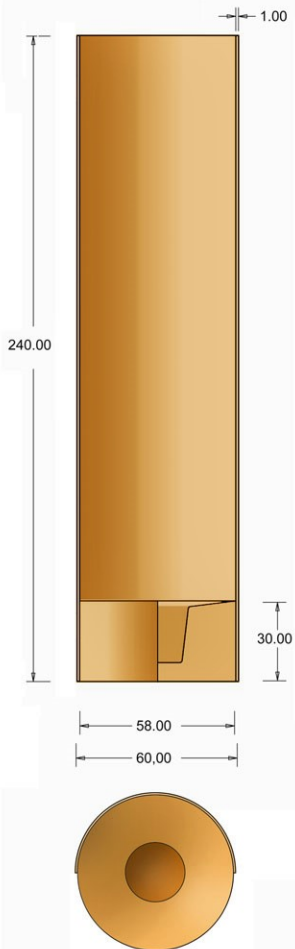

CANDLE TUBE MEDIUM

2003-06-11
Design Magnus Lofgren
MAGNUS LOFGREN DESIGNS

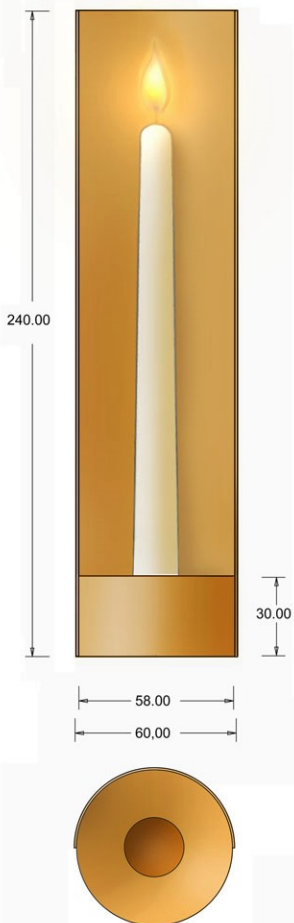

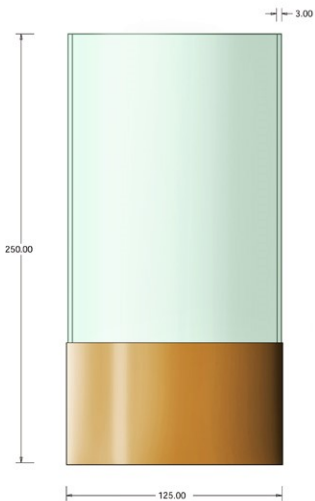

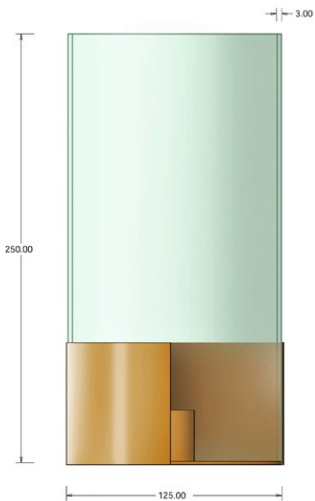

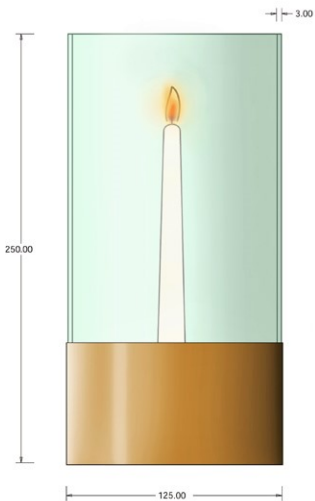

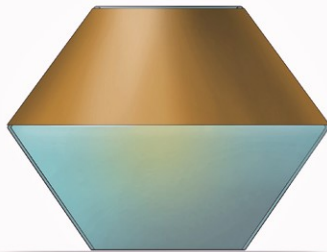
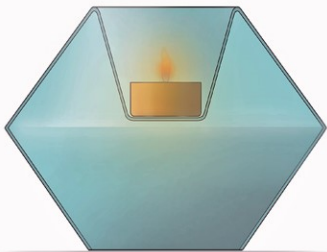

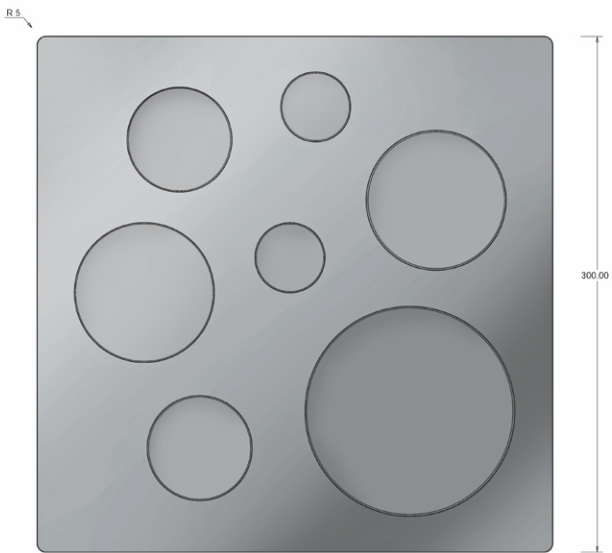
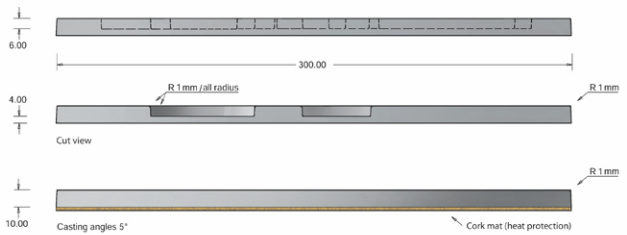

MATERIAL: CAST ALUMINUM

BOTTOM DIAMETER HOLES 42 / 62 / 82 / 122mm

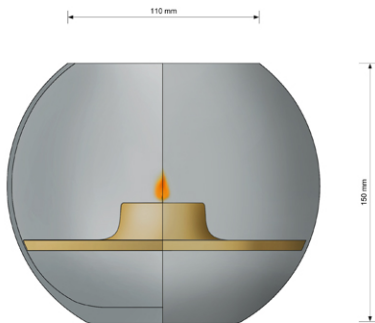

MATERIAL GLASS / METAL

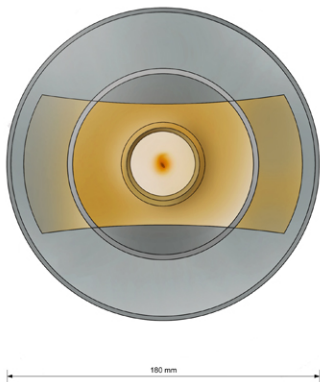

MATERIAL GLASS / METAL

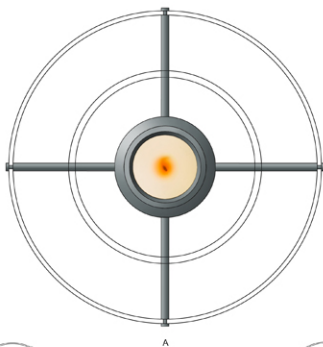
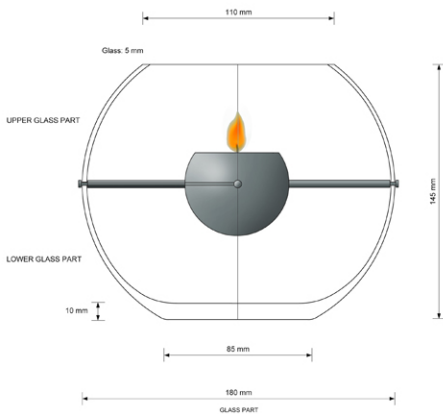

METAL PART ON SEPARATE DRAWING



MATERIAL GLASS / METAL

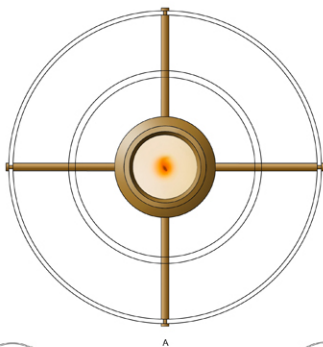
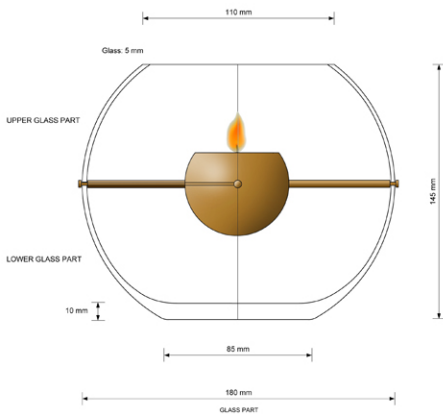

METAL PART ON SEPARATE DRAWING



MATERIAL GLASS / METAL

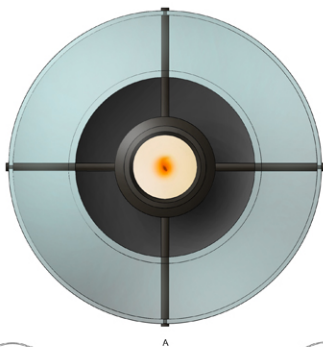
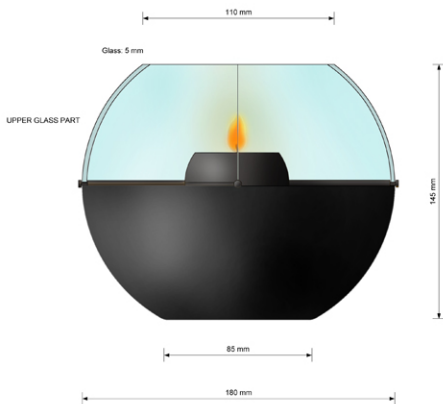

METAL PART ON SEPARATE DRAWING



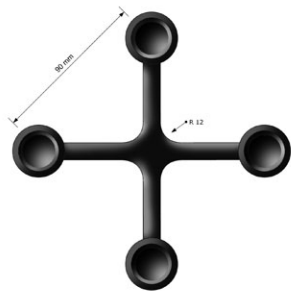
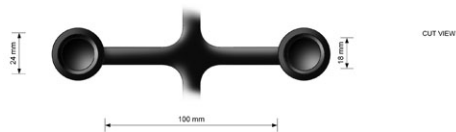
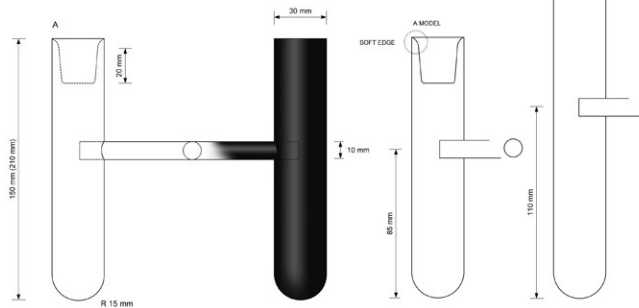

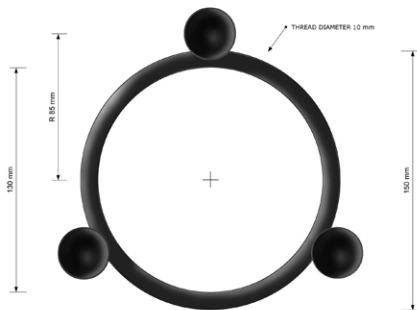
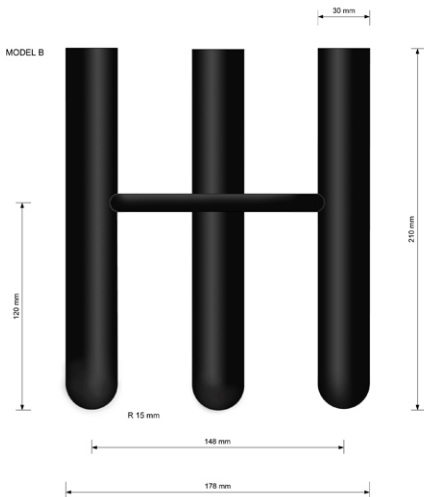



MATERIAL: CAST METAL



MATERIAL: CAST METAL



MATERIAL: CAST METAL

VOTIVE IN CAST GLASS
FOR TEALIGHT SMALL / LARGE

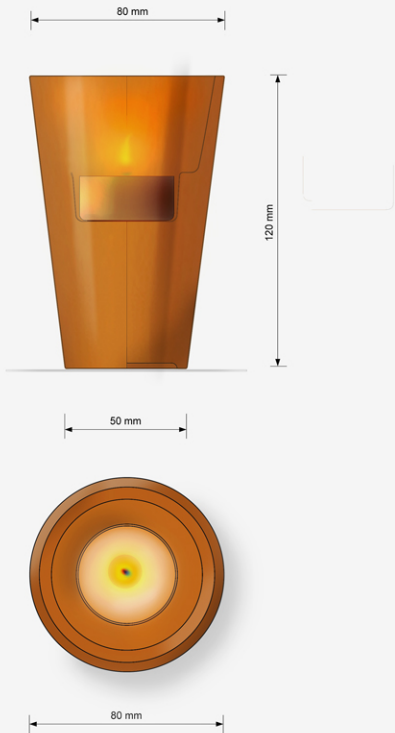

VOTIVE IN CAST GLASS
FOR TEALIGHT SMALL / LARGE

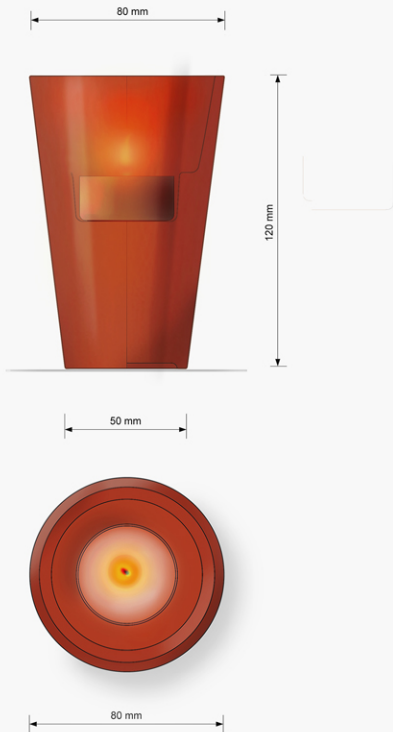

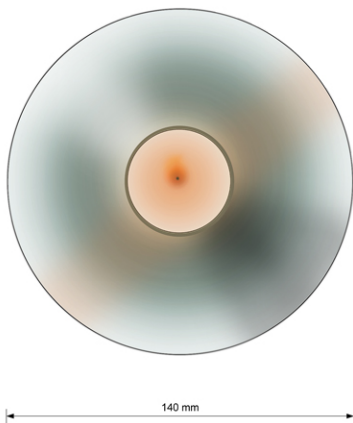
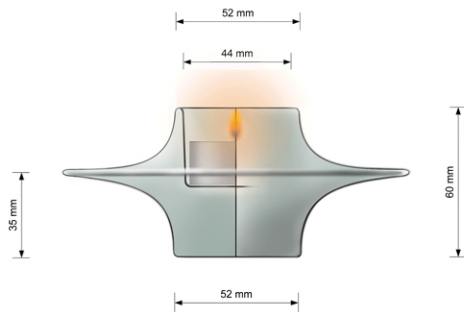

VOTIVE FOR TEALIGHT 38mm

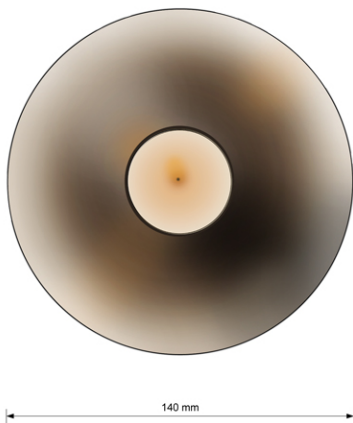
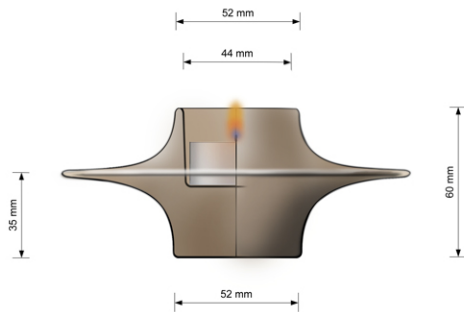

VOTIVE FOR TEALIGHT 38mm

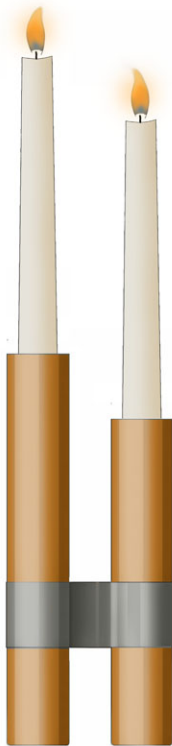

METAL FLEXIBLE BAND



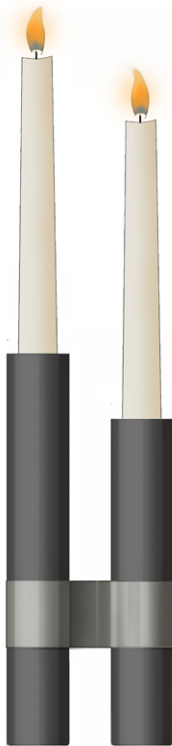

METAL FLEXIBLE BAND





MATERIAL GLASS / METAL



MATERIAL GLASS / METAL



METAL PART

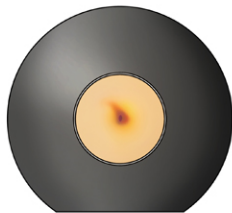

Thank you for looking.

The presentations should be regarded as the beginning of a creative dialogue, between producer and designer.

For more info contact:

info@magnuslofgrendesigns.se